



USER MANUAL SmarTrak (ST2)



User manual

Referred to :

Fw revision starting from 2.00
RC software revision starting from 2.00





USER MANUAL

SmarTrak (ST2)



SUMMARY

Description	5
CONTROLLER MOUNTING	5
Manufacturer's identification :	6
GENERAL SAFETY INSTRUCTIONS	8
Installation	8
Maintenance	8
Controller sw upgrade	9
RemoteControl sw installation	11
RemoteControl sw connection	11
USB connection :	11
Starting the sw	11
The Main page	12
Quick Buttons	13
Download button	13
Graph button	13
Password button	13
'Tuning window'	14
'Travel Control' area	14
Definitions :	14
0 Ctrl Signal :	14
0 Position :	14
Low [0..50 %]:	14
High [50..100 %]:	14
Tuning :	14
Kp IN/OUT [0 .. 100]:	14
Stroke Time IN/OUT [0,0 ..3000,0 sec]:	14
Approach IN/OUT [0..100]:	14
Dead Band [0..10] :	14
'IN/OUT window'	15
Fail/Trip settings	15
Mode C1/C2 :	15
Ack END MODE	15
On St.	15
SOV	16
SOV ASSIGNEMENT	17
SOV BOOSTER FUNCTION	18
Analog Outputs	22
Temperature	22
Date & Time	22
History and Diagnostic	23
Counters :	23
Example of Diagnostic Report :	24
Historic event log	26
Periodic log (SD Card)	27
SDCard :	27
Main vars and status	28
ActPos [%] :	28
ReqPos [%]:	28
Input [mA]:	28
Status :	28
Errors:	28
Service State / Mode :	29
Channel 1 CFG window (Channel 2 CFG window)	30
CALIBRATION	30
INPUT SIGNAL : Split range	30



USER MANUAL

SmarTrak (ST2)



INPUT SIGNAL : Calibrate 4mA	30
INPUT SIGNAL : Calibrate 20mA	30
Change Description	30
Position excess Fail	32
Signal Fail.....	32
Probe Fail.....	32
HART panel	33
HART PARAMETERS.....	33
Tag :	33
Date :	33
Descriptor :	33
Message :	33
Polling address:.....	33
Dev. ID :	33
HART Protocol	33
HART Communication	33
Hart Mode :	33
The Graph window.....	34
The Graph Menu.....	35
File : Save Image	35
File : Save Snapshot	35
File : Load Snapshot.....	35
File : Load History File.....	35
File : Convert History File.....	35
STI Advanced Panel	36
Probe (STI Advanced Panel).....	36
Proportional valve (STI Advanced Panel).....	37
FB Current Value :	37
Manual control :	37
Calibration type :	37
SOV (STI Advanced Panel)	38
Feedback :	38
Manual Settings.....	38
4-20mA (STI Advanced Panel)	39
An. Inputs (STI Advanced Panel)	40
General (STI Advanced Panel).....	41
'Erase calibration' :	41
'Set as default' :	41
Reset to default':	41
'Upload' :	41
'Reset factory default' :	41
'Save parameters' :	41
'Memory test' :	41
Trips detection time:	41
SD CARD : Pre Trigger Time	41
SD CARD : Log Time	41
The Menu.....	42
Menu : File	42
Load:	42
Save :	42
Report :	42
Exit :	42
Menu : Device	42
Download	42
Example of Configuration Report	43
SYSTEM INFORMATION.....	43
TRAVEL CONTROL	43



USER MANUAL

SmarTrak (ST2)



TUNING	43
Parameter	43
Channel 1	43
Channel 2	43
FAIL TRIP SETTINGS	43
SOV STATUS	44
Channel 1	47
Channel 2	47
Menu : Password	49
Login	49
Change	49
Menu : ? Info	49
Electrical connections:	50
Application example :	50
Terminal Board : wiring specification and electrical rating	51
Terminal board from 1 to 50 and from 100 to 113 :	52
Terminal board from 51 to 70	52
Terminal board from 80 to 81	52
Terminal Board : pinout	53
Terminal board from 1 to 50	53
Terminal board from 51 to 70	54
Terminal board from 80 to 82	54
Terminal board from 100 to 113	54
Position Feedback Probe	55
Analog Input (pressure sensors)	56
4-20mA IN : Request position	57
4-20mA OUT	58
Digital output	59
TRIP : Digital Input	60
ON/OFF SOV	60
Proportional Valve	61
Power supply	61
AC universal input (standard solution) :	61
DC 24V= input :	61
DC 24V= input without isolation :	61
Options	61
How To (advanced user configuration guide)	62
Configure SOV and TRIP	62
Setting the the Trip signal Type :	63
Setting the Activation Status :	63
Setting the SOV :	64
Configure Power reduction and test the SOV	65
Configure the Proportional Valve	66
Select the type of proportional valve	66
TROUBLE SHOOTING	67
ST2Mono : single channel version	69
Differences :	69
ST2Mono Power supply :	69
ST2Mono : terminal board	69



USER MANUAL

SmarTrak (ST2)



DESCRIPTION

The “SmarTrak” controller is used as a positioning system for proportionally-driven hydraulic actuators. Fast stroke and superior resolution allow the unit to be applied on severe service hydraulic actuators demanding fast stroking and precise positioning. SmarTrak system covers a wide range of actuator size and stroke length requirements. SmarTrak 2 is able to drive two fully independent actuators.

The SmarTrak controller must be connected to the following devices:

1. feedback probe (for each actuator) which detects the hydraulic actuator's actual position;
2. one modulating valve (for each actuator);
3. up to 3 on-off solenoid (for each channel);
4. optional pressure/temperature (4-20mA signal) sensors.

On the customer's side power supply, 4-20mA signal (request position) and if required trip signal and output signal must be connected.

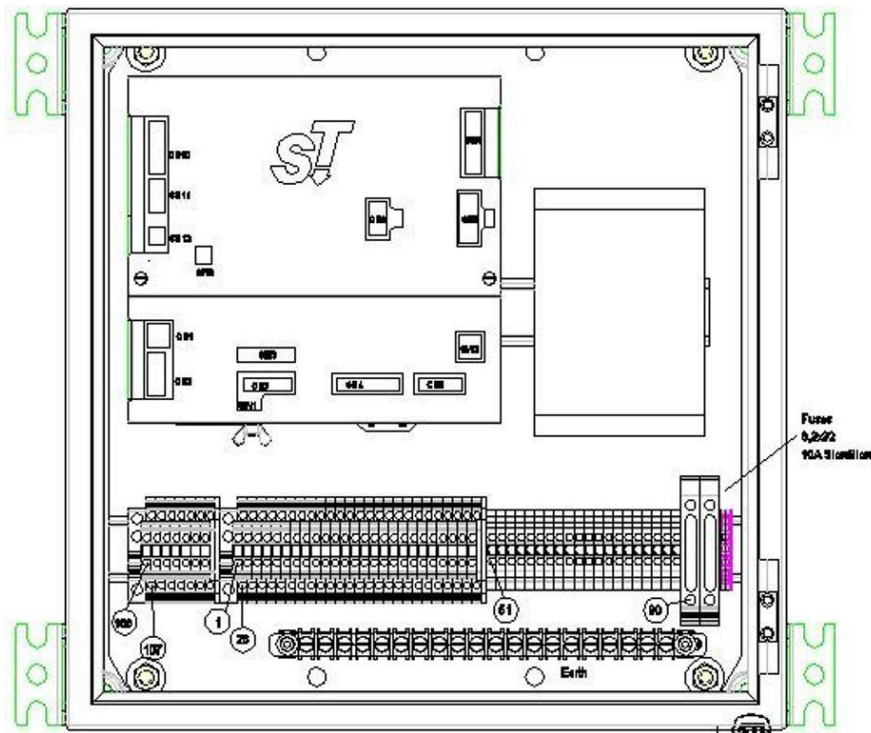

CONTROLLER MOUNTING

The controller enclosure is rated for NEMA4 (NEMA4X when the Stainless Steel) / IP66 environment, which is watertight to “wash down”, such as a water hose. Outdoor mounting is acceptable, however, the controller should be protected from direct sunlight by a suitable sun shield (see temperature ratings).



USER MANUAL SmarTrak (ST2)



Manufacturer's identification :

Every controller SmarTrak is provided with a name plate with its serial number. The year of manufacturing is indicated by the first two numbers of the serial number.

Do not remove it and/or replace with other name plates.





USER MANUAL

SmarTrak (ST2)



The decoder of the manufacturer's model can be made by means of the following table:

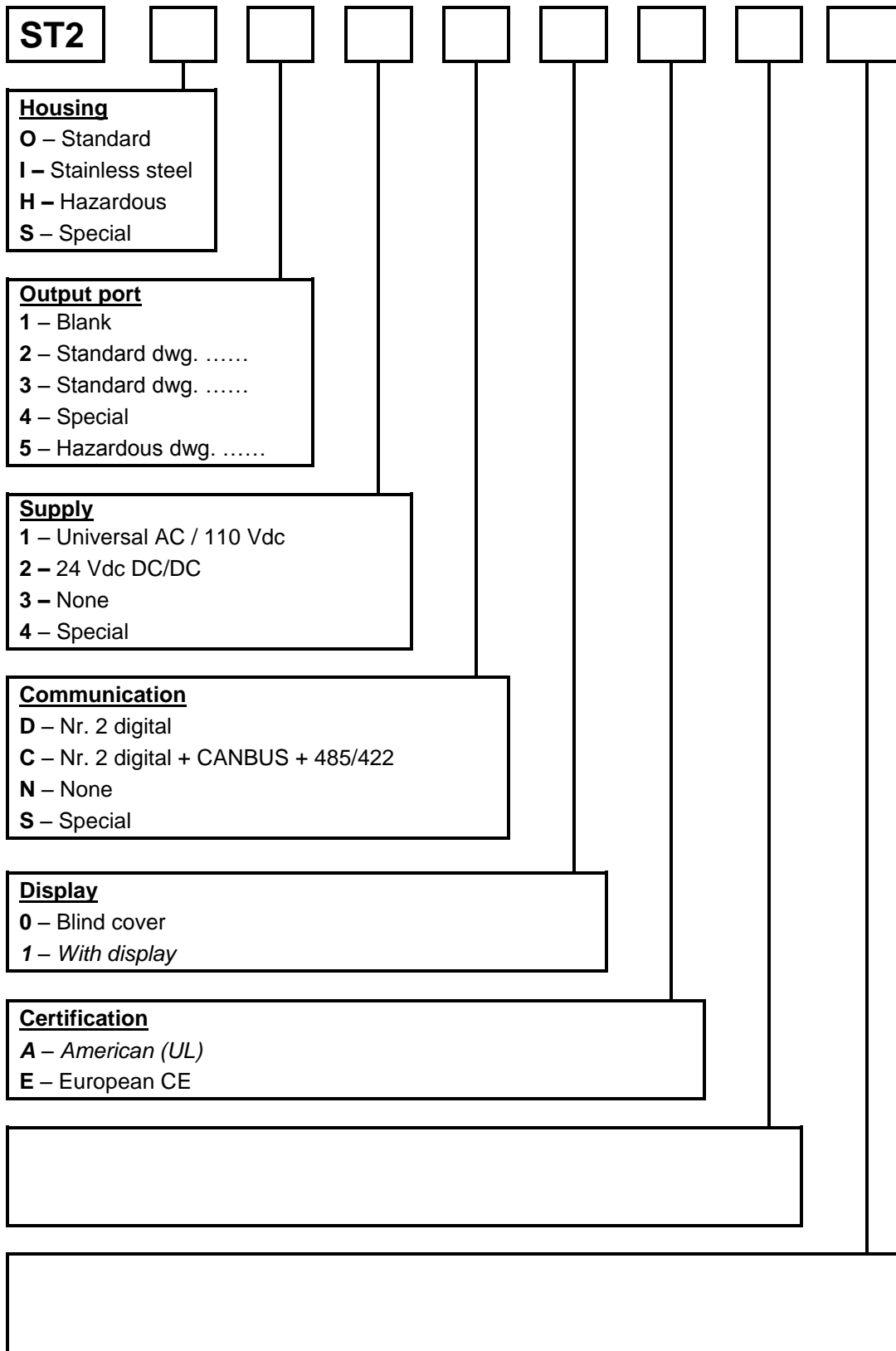



USER MANUAL

SmarTrak (ST2)



GENERAL SAFETY INSTRUCTIONS

The non-observation of the following safety instructions and of the instruction manuals can result in serious injury.

Installation

- Must be done by qualified person trained to operate.
- A ground tap is necessary.
- The electrical and hydraulic connections must be done according to the diagram and label.
- The supply circuit must be protected in case of current exceeding the limit fixed.
- The equipment must be provided with cable entries and filler plugs certified according to the required certification.
- The actuator must be installed and used according to the project design specification.
- The fluid must be chemically compatible with the used gaskets and lubricant.

Maintenance

- Must be done by qualified person.
- Cleaning must be done with a humid cloth.
- Greases and oils must be used according to the manufacturer's instructions, however their flammability point must be $> 140^{\circ}\text{C}$.



USER MANUAL

SmarTrak (ST2)



Controller sw upgrade

The software is factory installed in the controller. For a new installation, a "Loader" program is necessary. It can be installed selecting the file SETUP.exe from the supplied LOADER software cd.

A shortcut should appear in the program selection of start menu. Select the "Loader" access program:

Program » Loader » Loader

Or select it directly:

C:\Program Files\STI s.r.l.\Loader\Loader.exe

The following window will appear:

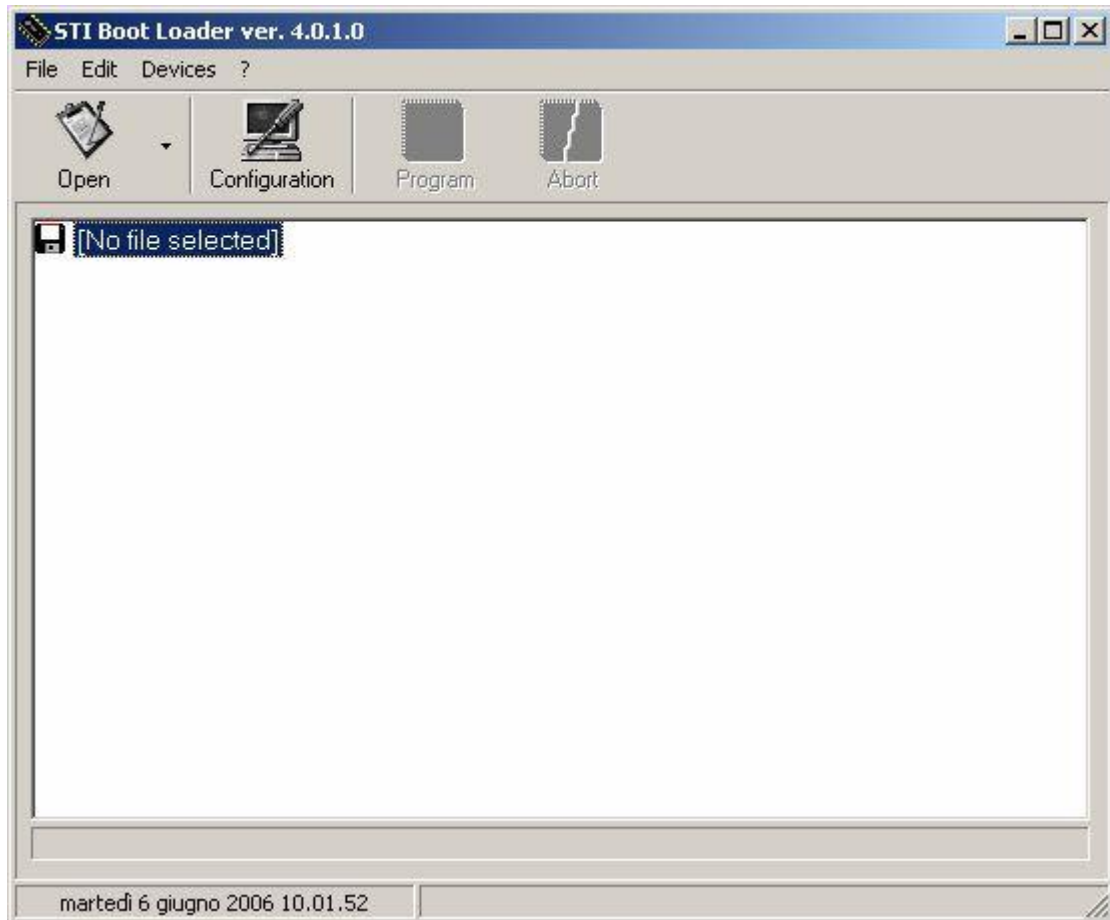



USER MANUAL

SmarTrak (ST2)



Configure the PC COM port selecting: "Configuration" from EDIT menu for "Texas 2812 DSP".



Copy the DSP software to be installed to a folder on the laptop. File extension should be ".hex". Perform the following steps on the SmarTrak controller to prepare it for software loading.

- Turn off the controller by the main power switch.
- Change the switches SW1 as showed in SW Upgrade mode.

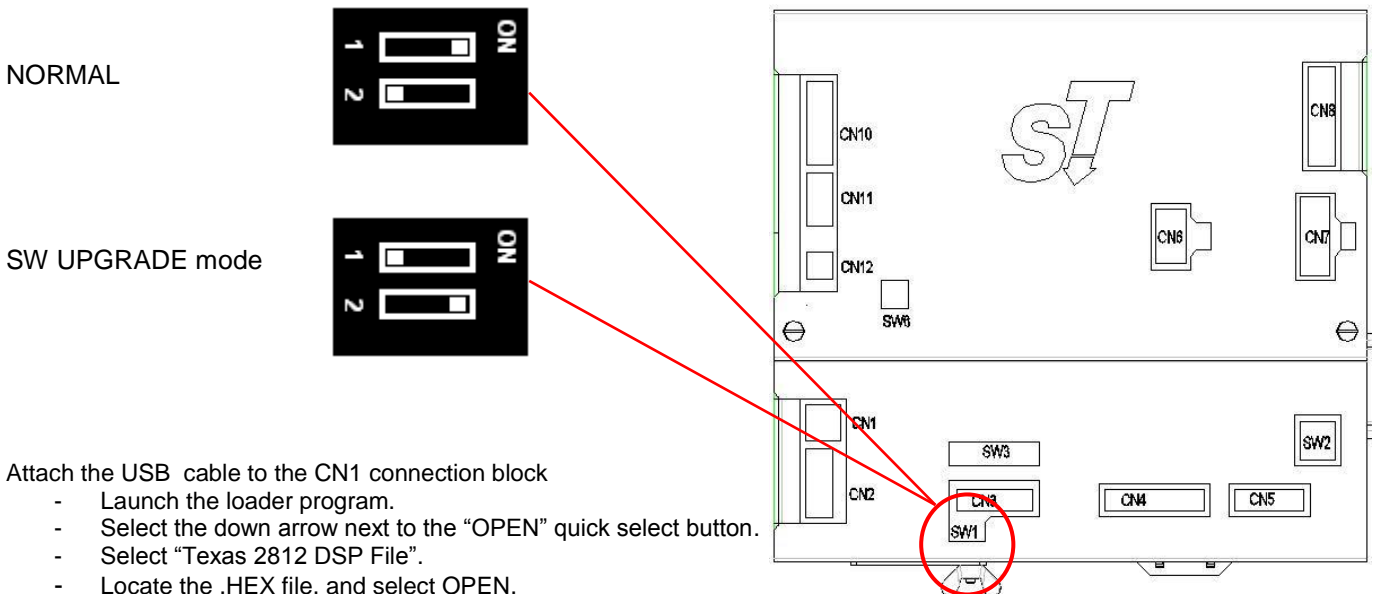

Attach the USB cable to the CN1 connection block

- Launch the loader program.
- Select the down arrow next to the "OPEN" quick select button.
- Select "Texas 2812 DSP File".
- Locate the .HEX file, and select OPEN.
- Turn on the controller.
- Select the "Program" quick select button.
-



The program should run to completion

- Upon completion select File » Exit.
- Turn off the controller.
- Change the switches SW1 as showed in Normal mode.



USER MANUAL

SmarTrak (ST2)



RemoteControl sw installation

- Insert the CD (or download the installation file).
- Run setup.exe.
- Follow the instruction on the desktop.

RemoteControl sw connection

USB connection:

Connect a standard USB 'A' to 'B' cable from your computer to the ST2 USB port CN1

When the USB connection is used a specific USB driver is required.

The USB driver is usually provided with the RemoteControl installation file or can be download from <http://www.ftdichip.com/Drivers/VCP.htm> with reference to FT232R device.

If communication problems are recognized check the 'latency timer' in the advanced properties of the COM port assigned and set it to 1ms.



Starting the sw

- Run the sw starting from the desktop icon or from the Windows Start menu.

The 'Select Communication' page is displayed.

- Select the right communication port
-  Only the available communication ports are displayed in the combo box.
- Select the Communication mode (RS232 or HART)
- Press the 'OK' button

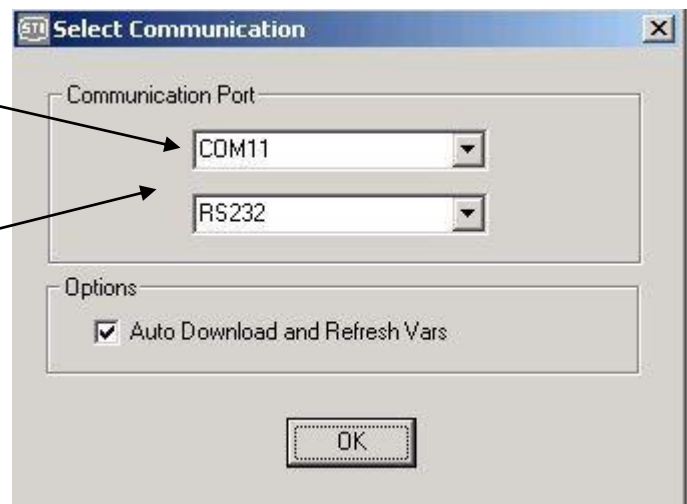



USER MANUAL SmarTrak (ST2)



The Main page

QUICK BUTTONS

MAIN VARS

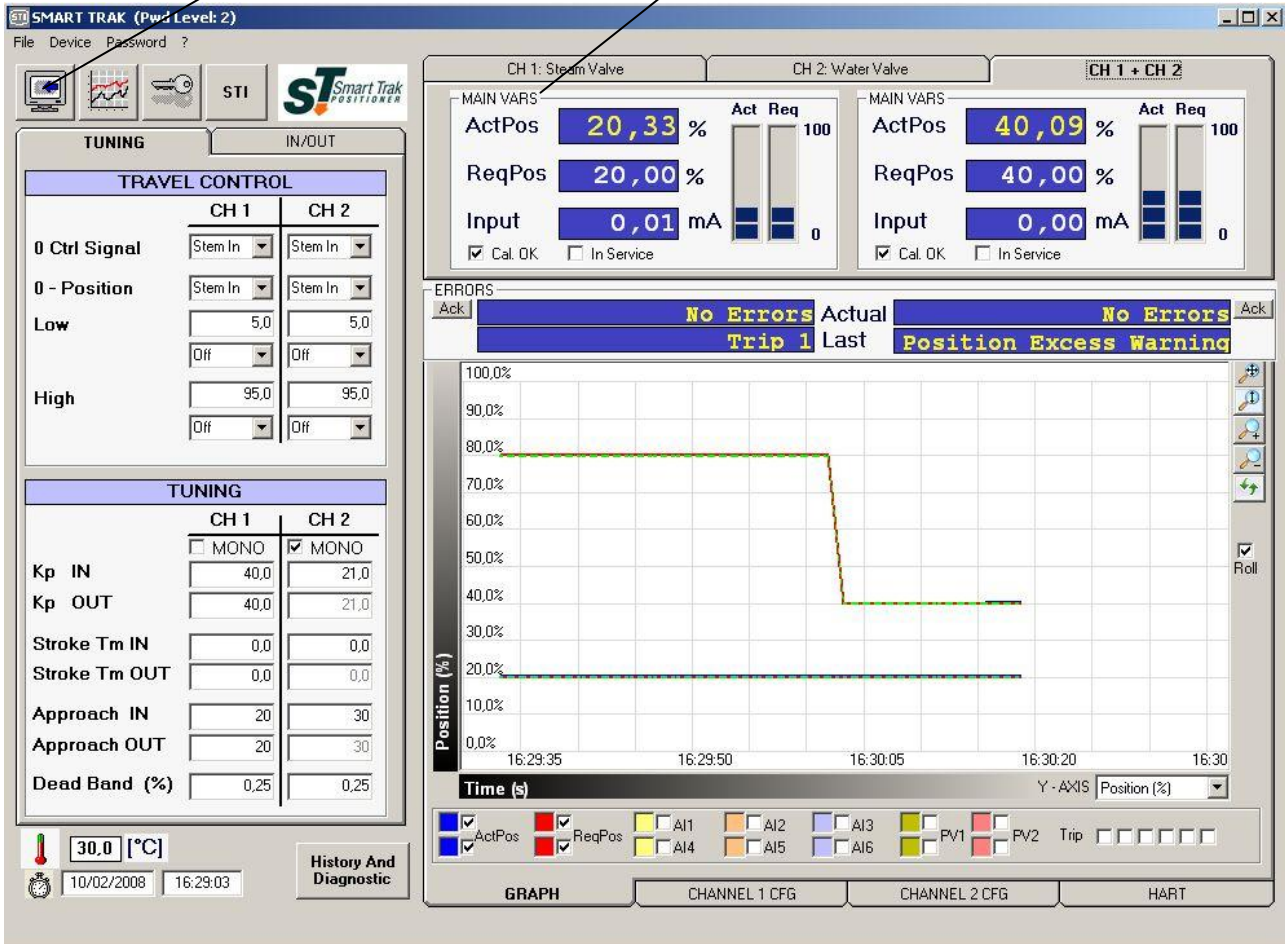



USER MANUAL

SmarTrak (ST2)



Quick Buttons

Download button



Download all the parameters from ST2.
At the end of the download the values displayed on the RC sw are the same of the ST2 positioner.

Graph button



Open the Graph window.

Password button



Open the Login window
In order to change the parameters value or to access the various configuration windows a login is request.
The default standard password is: 12345.



'Tuning window'

'Travel Control' area

Definitions:

Limit: when a limit is configured the Request position is limited at this value.

Example: Set the Limit at 95%. Even if the signal input is 20mA and the theoretical Request position is 100%, the applied Request position is 95%

CutOff : when a CutOff is configured if the Actual position falls inside the CutOff area the Request position is fixed at the min (or max) value.

Example: Set the CutOff at 5%. When the Request position is less of 5% and the Actual position is less of 5% a fixed pressure is applied in order to put the actual position at 0%.



WARNING

On some type of valves it is mandatory to enable a CutOff to ensure that the valve works properly (to ensure full trust on sit).

0 Ctrl Signal:

Specify the relationship between 4-20mA signal input and stem position.

'Stem in' means that you want that the Stem is in 'in position' when you apply 4mA.

'Stem out' means that you want that the Stem is in 'out position' when you apply 4mA.

0 Position:

Specify the relationship between 0-100% indication (a 4-20mA Out) and stem position.

'Stem in' means that 0% position is when the Stem is in 'in position'.

'Stem out' means that 0% position is when the Stem is in 'out position'.

Low [0..50 %]:

Specify if a Limit or a CutOff is configured in the close direction.

High [50..100 %]:

Specify if a Limit or a CutOff is configured in the open direction.

Tuning:



A lot of parameter are configurable with a different value in the Open direction and in the close one. This is to maximize the performance of the system.

If the *Mono* flag is checked the first value of each parameter is automatically copied in the second one.

Kp IN/OUT [0 .. 100]:

Proportional gain is the multiplier of the error (difference between input signal and actuator actual position) and it is expressed in percent. It is active only for an error which is bigger than dead band value.

A different gain for each stem direction can be imposed.

Stroke Time IN/OUT [0,0 ..3000,0 sec]:

The value expressed in seconds of the stroking time for each direction.

Approach IN/OUT [0..100]:

Special parameter, similar to a derivative factor, used to control overshoot.

Dead Band [0..10] :

Dead band prevents (at expense of the accuracy) that the valve, in the controlled condition, keeps continuously hunting for the target position.



'IN/OUT window'

Fail/Trip settings

Configure the digital input for TRIP function.
Up to 6 digital input are available.
For each digital input you can configure:

Mode C1/C2:

Error mode for channel 1 and channel 2.
It is possible to define the action to do when the TRIP input is ON.

Normally a TRIP is related only to one channel, but it is possible to set an error mode for both the channels.

- *Off/DirectDriveMode/Booster Enabled Mode* :
The TRIP is not used or it is assigned for Direct Drive function (See SOV configuration)
- *SafetyShutdown* :
Up to 3 different Safety mode for each channel.
The SOV activation in each SafetyShutdown mode is define in the SOV configuration panel
- *Modulation valve* :
The actuator is driven to a specific position specified in the 'Pos' field that is showed when 'Modulation Valve' is selected
- *Freeze* :
Actuator freezes in the last position
- *Ack* :
Trip is used for the error acknowledgment in remote mode.
- *External SOV* :
External safety shut down valve has been activated.

Ack END MODE

The end mode option allows to configure the action to be executed at the end of the error conditions.

On St.

This option allows to configure the ON status for the selected trip.
'E' means: when the input is energized (contact is closed or voltage is applied).
'nE' means: when the input is de-energized (contact is open or voltage is not applied).

For safety reason the best choice is 'nE': if a wire is cut off you are able to recognize this potential problem.

Err : Led used to show if a trip is activated (trip status , energized or not, is equal to 'On St' and a function , Mode C1/C2) is defined.

Hw : Led used to show if a trip is energized or not

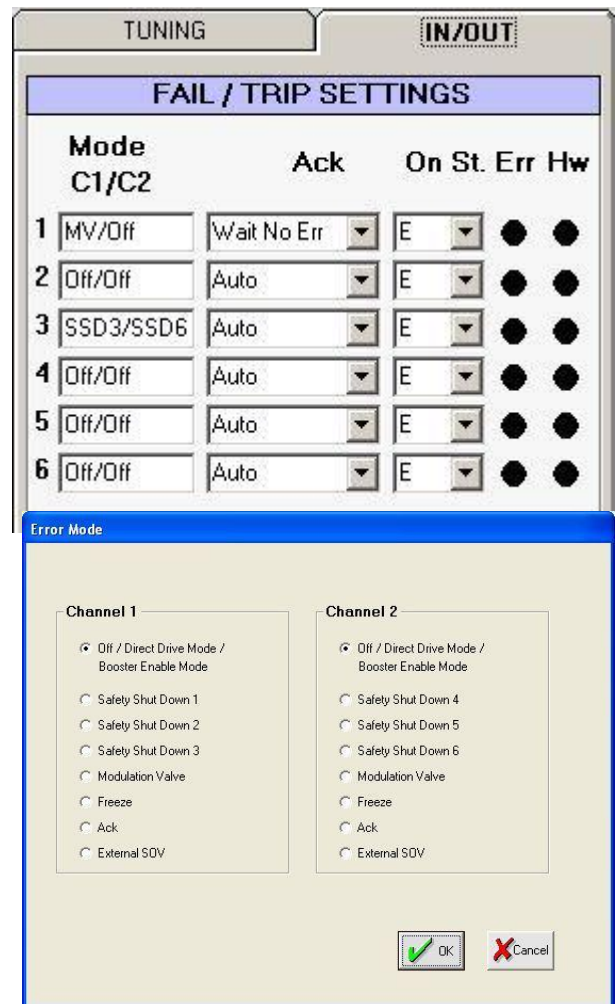



USER MANUAL SmarTrak (ST2)



SOV

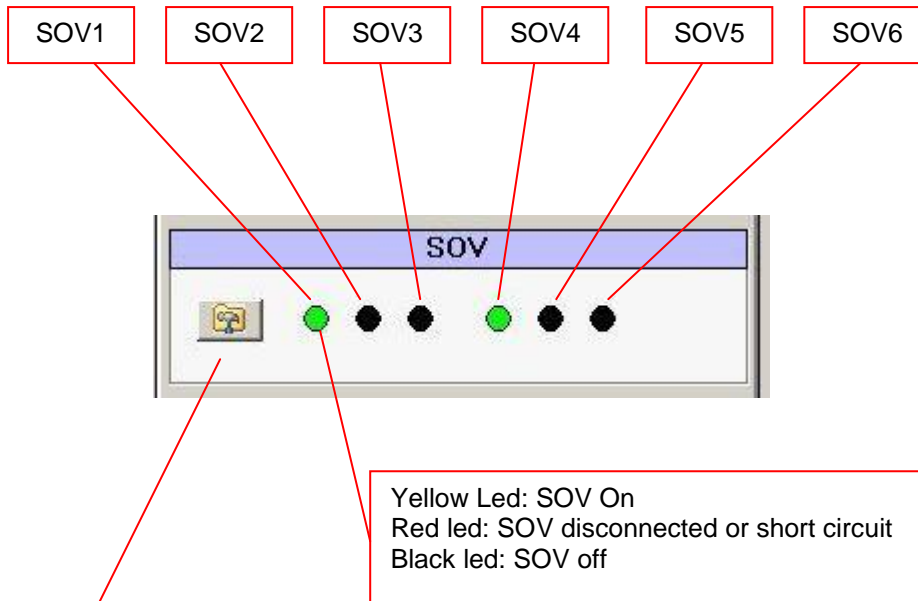

Configuration

SOV Configuration

SOV ASSIGNEMENT

SOV 1	SOV 2	SOV 3	SOV 4	SOV 5	SOV 6
Channel 2	Channel 2	Channel 2	Disconnected	Disconnected	Disconnected

Channel 1

	SOV					
	1	2	3	4	5	6
Running	<input type="checkbox"/>	<input type="checkbox"/>	<input type="checkbox"/>	<input type="checkbox"/>	<input type="checkbox"/>	<input type="checkbox"/>
Safety Shut Down 1	<input type="checkbox"/>	<input type="checkbox"/>	<input type="checkbox"/>	<input type="checkbox"/>	<input type="checkbox"/>	<input type="checkbox"/>
Safety Shut Down 2	<input type="checkbox"/>	<input type="checkbox"/>	<input type="checkbox"/>	<input type="checkbox"/>	<input type="checkbox"/>	<input type="checkbox"/>
Safety Shut Down 3	<input type="checkbox"/>	<input type="checkbox"/>	<input type="checkbox"/>	<input type="checkbox"/>	<input type="checkbox"/>	<input type="checkbox"/>

Booster						
Mode	Target	Activation Threshold	Disactivation Threshold	Use PV	Trip Nr.	
No	Stem In	51,00	21,00	<input type="checkbox"/>	Trip 1	
No	Stem In	52,00	22,00	<input type="checkbox"/>	Trip 2	
No	Stem In	53,00	23,00	<input type="checkbox"/>	Trip 3	

Channel 2

	SOV					
	1	2	3	4	5	6
Running	<input checked="" type="checkbox"/>	<input type="checkbox"/>	<input type="checkbox"/>	<input type="checkbox"/>	<input type="checkbox"/>	<input type="checkbox"/>
Safety Shut Down 4	<input type="checkbox"/>	<input type="checkbox"/>	<input type="checkbox"/>	<input type="checkbox"/>	<input type="checkbox"/>	<input type="checkbox"/>
Safety Shut Down 5	<input checked="" type="checkbox"/>	<input checked="" type="checkbox"/>	<input type="checkbox"/>	<input type="checkbox"/>	<input type="checkbox"/>	<input type="checkbox"/>
Safety Shut Down 6	<input type="checkbox"/>	<input type="checkbox"/>	<input type="checkbox"/>	<input type="checkbox"/>	<input type="checkbox"/>	<input type="checkbox"/>

Booster						
Mode	Target	Activation Threshold	Disactivation Threshold	Use PV	Trip Nr.	
With Enable	Stem Out	50,00	5,00	<input checked="" type="checkbox"/>	Trip 1	
With Enable	Stem In	50,00	5,00	<input type="checkbox"/>	Trip 1	
No	Stem In	50,00	20,00	<input type="checkbox"/>	Trip 1	

OK Cancel



USER MANUAL

SmarTrak (ST2)



SOV ASSIGNEMENT

Select if a SOV is assigned to Channel 1 or Channel 2 or if it is reserved for DirectDrive.

Selecting DirectDrive a SOV is not assigned to a specific channel and can be activated from a trip. This mode is used typically to drive ON/OFF Valve without feedback.

When a specific trip is assigned to a SOV for direct drive, a warning is showed if the trip is already assigned for other functions.

Channel 1 :

Only the SOV assigned to channel 1 are active and configurable in this panel.

The matrix specify if a SOV is activated or not in a specific Running/SafetyShutdown status.

Refer to "Configure SOV and TRIP" at the end of this instruction manual to understand how to set the SOV.

Channel 2 :

Only the SOV assigned to channel 2 are active and configurable in this panel.

The matrix specify if a SOV is activated or not in a specific Running/SafetyShutdown status.

Refer to "Configure SOV and TRIP" at the end of this instruction manual to understand how to set the SOV.



USER MANUAL

SmarTrak (ST2)



SOV BOOSTER FUNCTION

This feature come with sw release 2.0 .

The ON/OFF valves can be used in order to speedup the movement of big actuators.

Two operative modes are available:

- With enable
- Normal

When Booster 'with enable' is selected a specific TRIP signal is used like ENABLE of the booster : it means that you can have a big error and that the movement can happens only with the proportional valve (if the TRIP is not activated) or also with the ON/OFF valve.

When Booster 'normal' is selected every time the error is greater than the activation threshold the ON/OFF valve is used.

The Booster function is related to a SafetyShutdown mode and not to a specific SOV because in order to move in one specific direction the status of more than one SOV must be changed.

Configuration parameters :

Channel 2						
SOV						
	1	2	3	4	5	6
Running	<input checked="" type="checkbox"/>	<input type="checkbox"/>	<input type="checkbox"/>	<input type="checkbox"/>	<input type="checkbox"/>	<input type="checkbox"/>
Safety Shut Down 4	<input type="checkbox"/>	<input type="checkbox"/>	<input type="checkbox"/>	<input type="checkbox"/>	<input type="checkbox"/>	<input type="checkbox"/>
Safety Shut Down 5	<input checked="" type="checkbox"/>	<input checked="" type="checkbox"/>	<input type="checkbox"/>	<input type="checkbox"/>	<input type="checkbox"/>	<input type="checkbox"/>
Safety Shut Down 6	<input type="checkbox"/>	<input type="checkbox"/>	<input type="checkbox"/>	<input type="checkbox"/>	<input type="checkbox"/>	<input type="checkbox"/>

Booster					
Mode	Target	Activation Threshold	Disactivation Threshold	Use PV	Trip Nr.
With Enable	Stem Out	50,00	5,00	<input checked="" type="checkbox"/>	Trip 1
With Enable	Stem In	50,00	5,00	<input type="checkbox"/>	Trip 1
No	Stem In	50,00	20,00	<input type="checkbox"/>	Trip 1

Mode :

No : booster function is disabled.

Normal : booster function is enabled all the time based on the other configuration parameters.

With Enable : booster function is enabled based on the status of the TRIP channel specified on the same row.

Target :

We need to specify if this 'safety shutdown' mode move the actuator in the 'Stem IN' or 'Stem OUT' direction. Make attention: a wrong settings can cause an hydraulic short circuit (if the proportional valve is used with the booster).

Activation Threshold :

Is the minimum error that can start the booster activation.

Disactivation Threshold :

Is the residual error (when we are approaching the target) that stop the booster activation.

Use PV :

If this caption is selected the proportional valve works helping the movement during the booster action.

Trip Nr :

This parameter is used only when the mode is 'With enable' and specify the TRIP channel used to enable the booster function.

The TRIP signal is evaluated 'on the edge' and not 'on the level' , it means that in order to enable the booster the TRIP status must change from 'not active' to 'active'. It cannot be 'active' all the time, if you need the booster all the time you need to select mode='Normal'.

When the Mode is 'With Enable' the SafetyShutdown mode related to a booster cannot be used like in the previous sw versions for a Quickopen or QuickClose function because it is automatically disactivated when the error is less than the 'disactivation threshold'.



USER MANUAL

SmarTrak (ST2)



Examples of movement :

Booster 'with enable', PV not used.

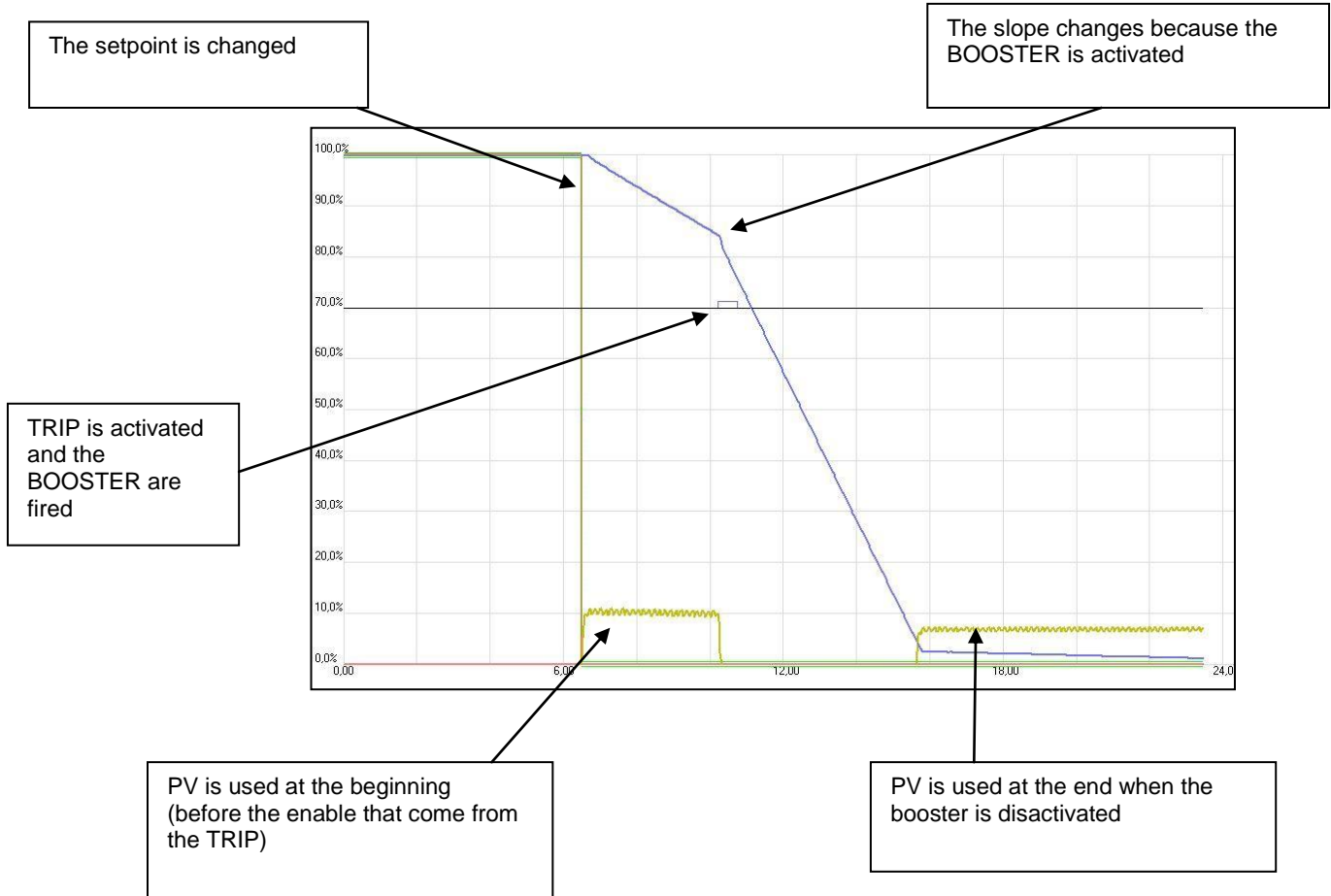



USER MANUAL SmarTrak (ST2)



Booster 'with enable', PV used.

The setpoint is changed

TRIP is activated and the BOOSTER are fired

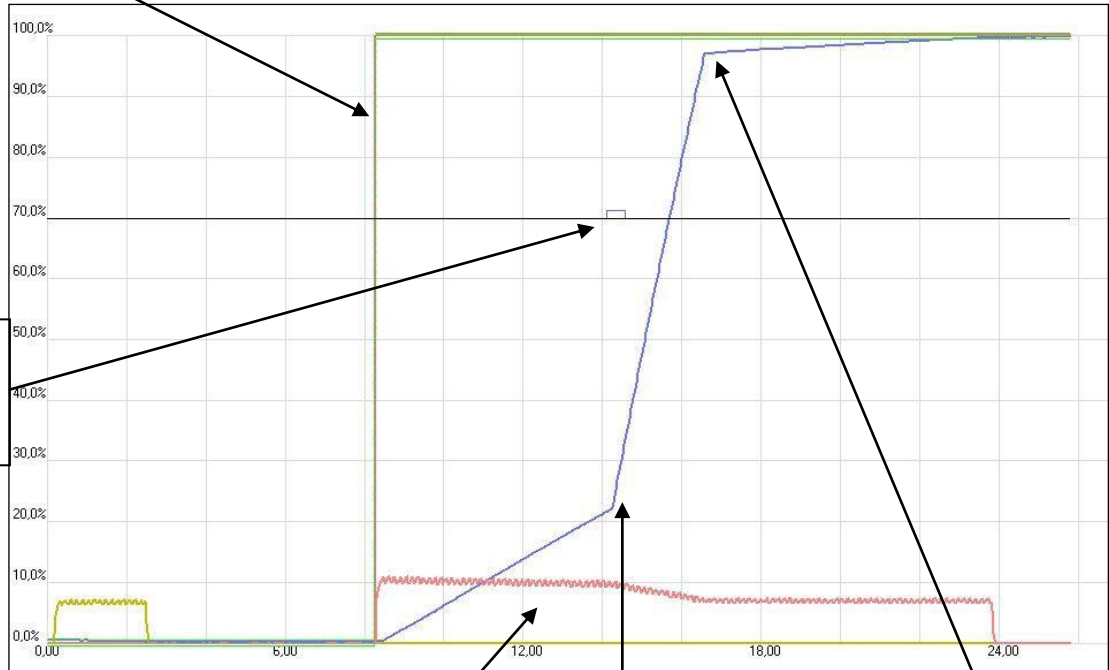

PV is used all the time

The slope changes because the BOOSTER is activated

The slope changes again because the BOOSTER is deactivated



USER MANUAL

SmarTrak (ST2)



Digital Output

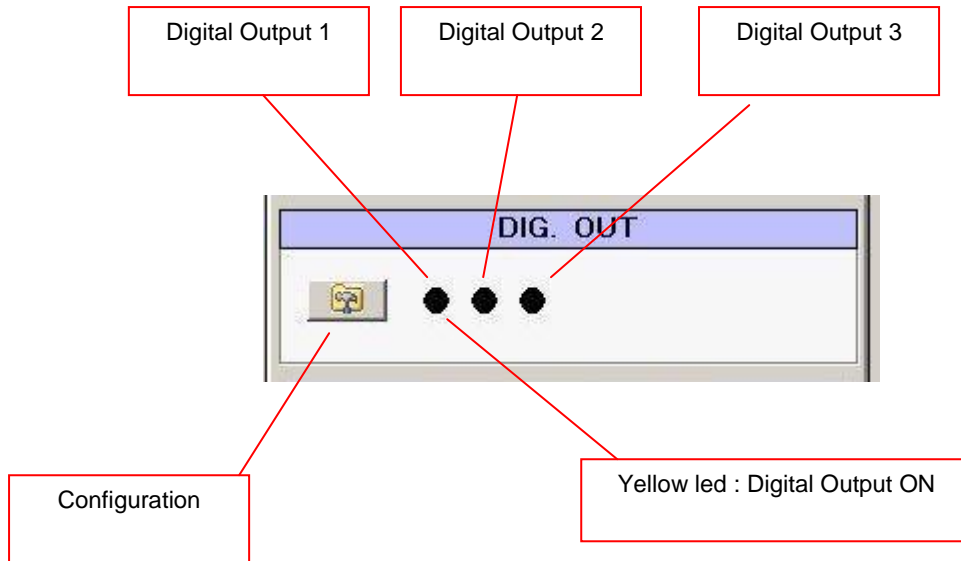

Three Digital Output are available, for each one it is possible to select different activation options.

When a Digital Output is configured it is Turned ON (the normally open contact of the relay is closed) if the error condition is not present and it is turned off when the error condition is true.

Selecting more than one error condition in one column the output is turned off when at least one condition is verified.

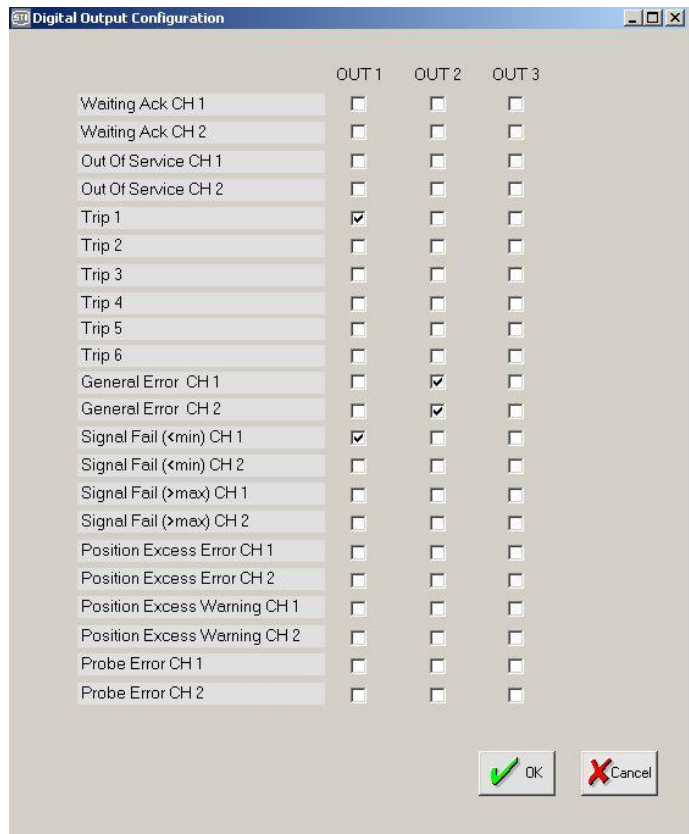



USER MANUAL

SmarTrak (ST2)



Analog Outputs

Two analog outputs are available.

It's possible to choose the required parameter, in order to associate it to the selected output channel for the reproduction of the indicated signal in a range from 4mA to 20 mA.

- ReqPosCh1 : required position of CH1, between 4÷20 mA
- ReqPosCh2 : required position of CH2, between 4÷20 mA
- ActPosCh1 : actuator position of CH1, between 4÷20 mA
- ActPosCh2 : actuator position of CH2, between 4÷20 mA
- InputCh1 : input signal of CH1 , between 4÷20 mA
- InputCh2 : input signal of CH2 , between 4÷20 mA
- Temperature : temperature in the controller box , between 0÷100°C
- AI1 : Analog input 1, between 4÷20 mA
- AI2 : Analog input 2, between 4÷20 mA
- AI3 : Analog input 3, between 4÷20 mA
- AI4 : Analog input 4, between 4÷20 mA
- AI5 : Analog input 5, between 4÷20 mA
- AI6 : Analog input 6, between 4÷20 mA

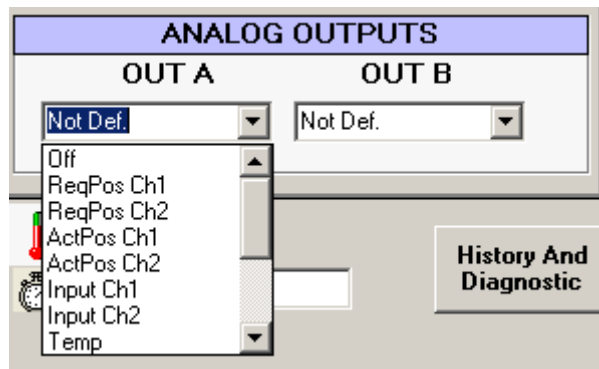

Temperature

Show the temperature inside the enclosure.



Date & Time

Show Date & Time of the controller.
This information is used for diagnostic purposes.

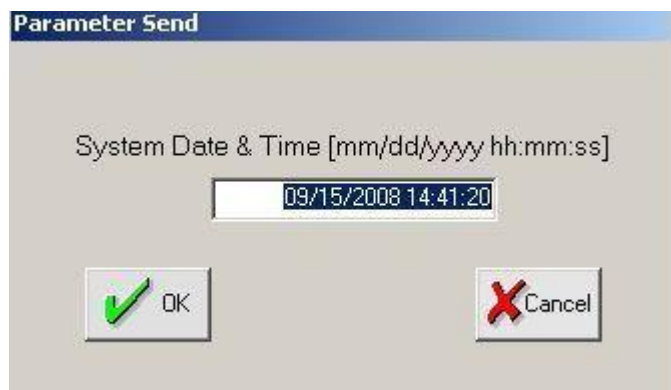

With a double-click it is possible to change the date&time (when you double-click a panel with actual date&time –taken from the laptop - is opened, pressing 'OK' this information is sent to the controller).



USER MANUAL

SmarTrak (ST2)



History and Diagnostic

Different level of diagnostic data are available.

- Counters
- Historic event log
- Periodic log (SD Card)
- Event log (SD Card)

COUNTERS

Historic Event Log

The screenshot displays the 'Diagnostics' window with the following sections:

- CH 1 and CH 2 Error Counters:** Tables showing counts and last dates for Signal <min, Signal >max, Pos. Exc. Error, Pos. Exc. Warn., Probe, Hard Limits, Calib. Erased, and Calibr. Aborted.
- System Counters:** Tables for Calibration, In Service, and Out Of Service.
- Position History:** Tables for Total Stroke and time in various stroke ranges (0.1, 1.25, 25.50, 50.75, 75.99, 99.100) and In Service Time.
- Alarm Counters:** Tables for Trip 1-6 and Error on SOV 1-6.
- Temperature [°C]:** Min, Max, and Average values.
- EVENT LOG:** A scrollable list of system events with timestamps and descriptions, including 'System Turned ON', 'Trip 1', 'Probe Error', and 'Calibration Aborted'.

Counters :

The controller record the number of time that an event happens and the last time and date of this event. Events are grouped in three main groups : Channel 1, Channel 2 and Alarm Counters



Press the 'download' button to get data from the positioner

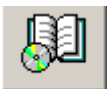

Press the 'Report' button to make a file (in .rtf format) with all the data



Press the 'Exit' button to close the window



USER MANUAL

SmarTrak (ST2)



Example of Diagnostic Report :

Report Date : 13/10/2008 15.20

CHANNEL 1

Error	Counter	Date
Signal <min	: 0	
Pos.Exc.Error	: 0	
Pos.Exc.Warn.	: 0	
Probe	: 2	10/10/2008 18:31:11
Hard Limits	: 0	
Calib. Erased	: 0	
Calibr. Aborted	: 0	

System	Counter	Date
Calibration	: 0	
In Service	: 0	
Out Of Service	: 0	

Position History

Total Stroke (Stroke nr.) : 0h 00m 12s
Time in [0,1) : 6h 07m 30s
Time in [1,25) : 0h 04m 25s
Time in [25,50) : 0h 00m 00s
Time in [50,75) : 0h 00m 00s
Time in [75,99) : 0h 00m 00s
Time in [99,100) : 0h 00m 05s
In Service Time : 0h 00m 00s

CHANNEL 2

Error	Counter	Date
Signal <min	: 0	
Pos.Exc.Error	: 0	
Pos.Exc.Warn.	: 0	
Probe	: 2	10/10/2008 18:31:11
Hard Limits	: 0	
Calib. Erased	: 0	
Calibr. Aborted	: 0	

System	Counter	Date
Calibration	: 0	
In Service	: 0	
Out Of Service	: 0	

Position History

Total Stroke (Stroke nr.) : 0h 00m 06s
Time in [0,1) : 6h 12m 00s
Time in [1,25) : 0h 00m 00s
Time in [25,50) : 0h 00m 00s
Time in [50,75) : 0h 00m 00s
Time in [75,99) : 0h 00m 00s
Time in [99,100) : 0h 00m 00s
In Service Time : 0h 00m 00s

Alarm	Counter	Date
Trip 1	: 0	
Trip 2	: 0	
Trip 3	: 0	
Trip 4	: 0	
Trip 5	: 0	
Trip 6	: 0	
Error on SOV 1	: 0	



USER MANUAL

SmarTrak (ST2)



Error on SOV 2 : 0
Error on SOV 3 : 0
Error on SOV 4 : 0
Error on SOV 5 : 0
Error on SOV 6 : 0
EEPROM 0 : 0
EEPROM 1 : 0

Temperature [°C]

Min : 23.2
Max : 36.0
Average : 33.7

Events Log

10/13/2008 15:18:20 Log Time: 10 --> 2
10/13/2008 15:16:11 Log Time: 0 --> 10
10/13/2008 12:27:41 System Turned ON
10/10/2008 18:31:11 Ch1 Probe Error
10/10/2008 18:31:11 Ch2 Probe Error
10/10/2008 18:26:46 System Turned ON
10/10/2008 18:26:00 Ch2 Probe Error
10/10/2008 17:19:11 SOV3: Channel 1 --> Channel 2
10/10/2008 17:18:42 SOV2: Channel 1 --> Channel 2
10/10/2008 17:01:41 Trip 2 Err Mode: Off --> SSD1
10/10/2008 16:53:47 Ch1 Operation Mode: Stem Out --> Stem In
10/10/2008 16:53:41 Ch1 Operation Mode: Stem In --> Stem Out
10/10/2008 16:46:38 Ch1 HighLimit: 95,0 --> 96,0
10/10/2008 16:46:33 Ch1 LowLimit: 5,3 --> 5,0



USER MANUAL

SmarTrak (ST2)



Historic event log

Up to 500 events can be stored in the internal eeprom of the positioner.

The events are stored in a circular queue, so when the limit is reached the older elements are deleted to free space for the new elements.

Each element is recorded with : date, time, event specification.

 Press the 'Start Read' button to download the events from the positioned.

Events are downloaded starting from the most recent one.

 Press the 'Stop Read' button to stop the download.

Filter options are available to show only :

- Errors
- Warning
- Info

It is also possible to select a filter related to the channel : only Ch1, only Ch2, Ch1 & Ch2

Types of event :

- Ch x Signal < min
- Ch x Signal > max
- Ch x Position Error
- Ch x Position warning
- Ch x Probe Error
- Ch x Hard Limit
- Ch x Calibration Erased
- Ch x Calibration Aborted
- Ch x Calibration Completed
- In Service
- Out Of Service
- Trip x
- Error On SOV x
- Eeprom x
- System Startup

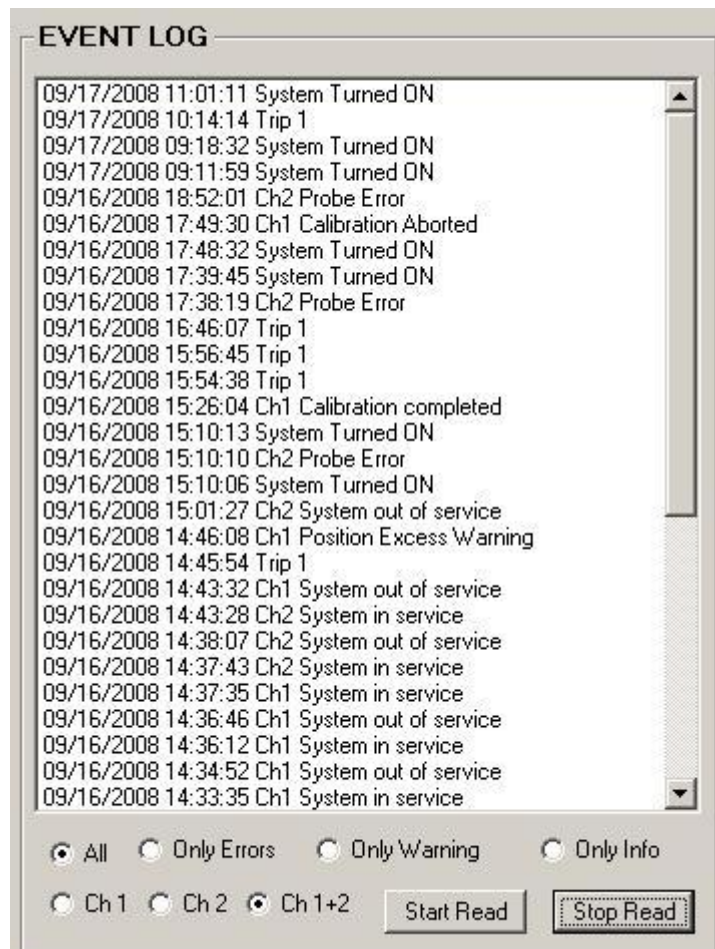



The screenshot shows a window titled "EVENT LOG" with a scrollable list of events. The events are listed in chronological order from top to bottom, with the most recent at the top. The events include system status changes, probe errors, calibration events, and position excess warnings. Below the list, there are radio buttons for filtering events by type (All, Only Errors, Only Warning, Only Info) and by channel (Ch 1, Ch 2, Ch 1+2). There are also "Start Read" and "Stop Read" buttons at the bottom right of the window.

EVENT LOG

- 09/17/2008 11:01:11 System Turned ON
- 09/17/2008 10:14:14 Trip 1
- 09/17/2008 09:18:32 System Turned ON
- 09/17/2008 09:11:59 System Turned ON
- 09/16/2008 18:52:01 Ch2 Probe Error
- 09/16/2008 17:49:30 Ch1 Calibration Aborted
- 09/16/2008 17:48:32 System Turned ON
- 09/16/2008 17:39:45 System Turned ON
- 09/16/2008 17:38:19 Ch2 Probe Error
- 09/16/2008 16:46:07 Trip 1
- 09/16/2008 15:56:45 Trip 1
- 09/16/2008 15:54:38 Trip 1
- 09/16/2008 15:26:04 Ch1 Calibration completed
- 09/16/2008 15:10:13 System Turned ON
- 09/16/2008 15:10:10 Ch2 Probe Error
- 09/16/2008 15:10:06 System Turned ON
- 09/16/2008 15:01:27 Ch2 System out of service
- 09/16/2008 14:46:08 Ch1 Position Excess Warning
- 09/16/2008 14:45:54 Trip 1
- 09/16/2008 14:43:32 Ch1 System out of service
- 09/16/2008 14:43:28 Ch2 System in service
- 09/16/2008 14:38:07 Ch2 System out of service
- 09/16/2008 14:37:43 Ch2 System in service
- 09/16/2008 14:37:35 Ch1 System in service
- 09/16/2008 14:36:46 Ch1 System out of service
- 09/16/2008 14:36:12 Ch1 System in service
- 09/16/2008 14:34:52 Ch1 System out of service
- 09/16/2008 14:33:35 Ch1 System in service

All Only Errors Only Warning Only Info

Ch 1 Ch 2 Ch 1+2



Periodic log (SD Card)

Inserting an SD Card in the slot an automatic process of data collection is activated.

The time between two consecutive recording is defined in the SDCARD LogTime parameter in the advanced STI menu. Typically the LogTime is equal to 10 minutes.

A file is created for each month of the year, the name of the file is DIAGymm (where 'yy' is the year and 'mm' is the month).

The Graph Tool allow :

- To open the History file and show the most important data
- To convert the History file in a .csv file (compatible with Excell and other spreadsheet)

Converting the History file you have access up to 30 different data to monitor the status of a positioner.

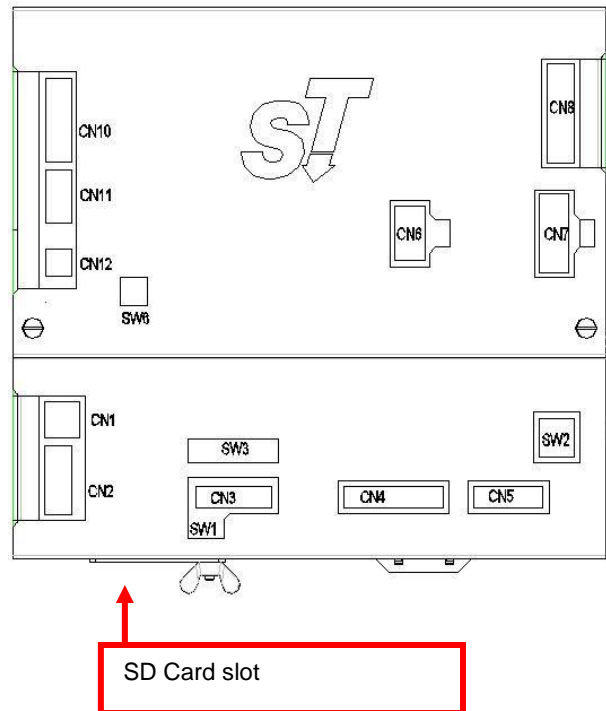

SDCard:

ST is able to manage standard SDCard formatted in FAT16 (storage capacity up to 2Gbyte). In the STI advanced panel it is possible to check if the SD is recognized or not.

Event log (SD Card)

- Every time an event happens a SnapShot is saved on the SD card.
- SnapShot is 20 seconds lenght with a sample rate of 100Hz.
- SnapShot is centered around the event (pretrigger is configurable in the advanced STI menu).
- The RemoteControl Graph tool is able to open and show a SnapShot file.
- SnapShot are saved with a name related to date/time/event_type in order to find the data in an easy way.

Events that start a snapshot are :

- Ch x Signal < min
- Ch x Signal > max
- Ch x Position Error
- Ch x Position warning
- Ch x Probe Error
- Ch x Hard Limit
- TRIP x



USER MANUAL

SmarTrak (ST2)



Main vars and status

This window report a collection of information about the status of the positioner.

You can select 3 different views :



- Channel 1 : only the information of the channel 1
- Channel 2 : only the information of the channel 2
- Channel 1 and 2 : the information of both the channels

ActPos [%] :

Actual position measured by the positioner.

ReqPos [%]:

Request position evaluated (the request position take in account the 'Service State', the 4-20ma input signal or manual setup, the transfer function and the split range)

Input [mA]:

Current read at the 4-20ma Loop current Input channel.



The user can align the value showed using the commands available in the 'CFG' area

Status :

The calibration status is showed

Errors:

Show , for each channel, the actual and the last error. More detailed information are available in the 'history and diagnostic' window.



USER MANUAL

SmarTrak (ST2)



Service State / Mode:

Allow the selection of the Service State.

- In Service : the Request Position is evaluated continually by the positioner starting from the 4-20ma signal value
- Out Of Service (Manual) : the Request Position come from the manual set in the window. When the Service Mode become 'Out Of Service (Manual)' the first manual setpoint is equal to the last 'Actual position' in order to minimize the movement of the system
- Out of Service : special mode selected automatically when the system is not calibrated. In this mode port B is fully pressurized and port A is depressurized

WARNING

Changing from 'Out of Service' to 'In Service' the system can move

The 'Main vars' window can show information in two ways :

Channel 1 & 2 : reduced set of information concerning the two channels in one page

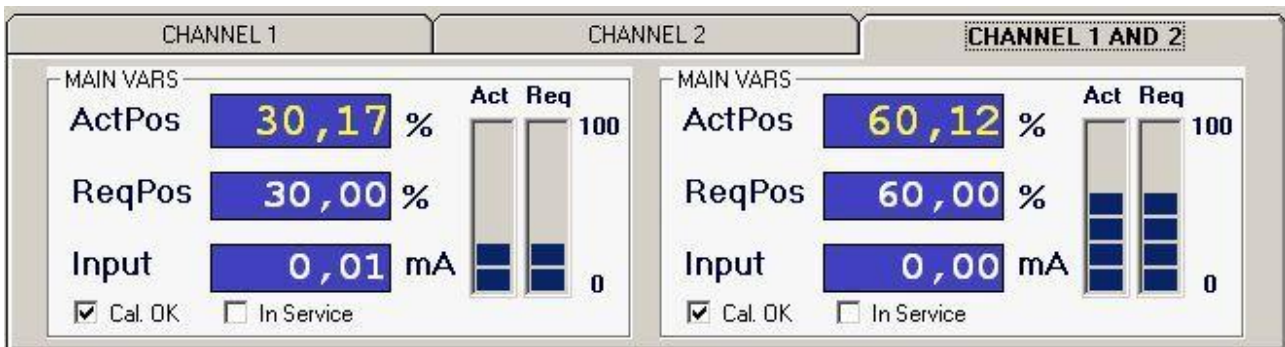

Only one channel : detailed information for one channel at a time

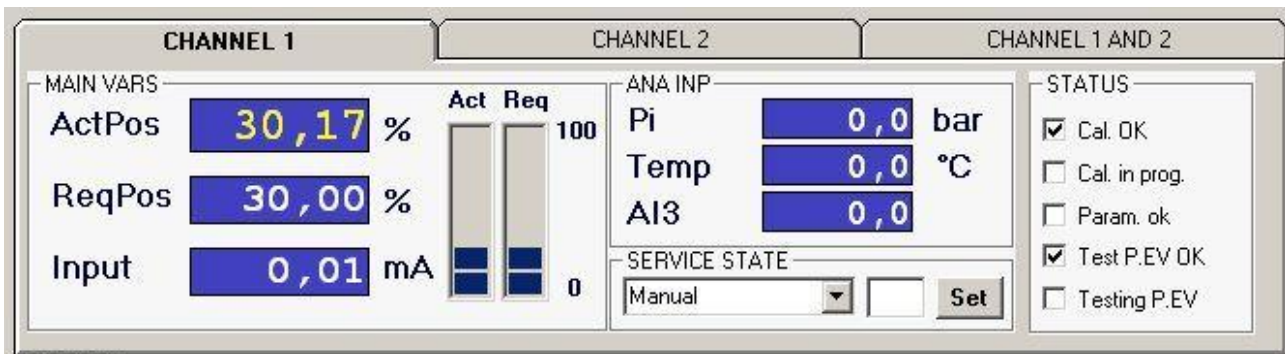



Channel 1 CFG window (Channel 2 CFG window)

CALIBRATION

Start Calibration Ch1

INPUT SIGNAL

Split Range L H

Calibrate 4mA Calibrate 20mA

INPUT CHAR

Linear Table

Change Description

POSITION EXCESS FAIL

Mode

Tolerance Time

Warning [%] [sec]

Error [%] [sec]

SIGNAL FAIL

Mode Ack

Min value [mA]

Position [%]

PROBE FAIL

Mode Ack

Steam Valve

GRAPH CHANNEL 1 CFG CHANNEL 2 CFG HART

CALIBRATION

Start the calibration procedure.

WARNING

When the 'Start Calibration' button is pressed the system can move.

INPUT SIGNAL : Split range

Enable the split range function.

The values in Lower range value and Upper range value are referred to the 4-20mA input.

A minimum distance of 20% is required between Lower and Upper value, so up to 5 split range area can be configured in different concatenated positioners.

The result of the split range is then evaluated by the 'Transfer Function Curve'.

If the Low range value is equal to 0% and Upper range value is equal to 100% the positioner interpret 4ma like the 0% Request position and the 20ma like 100%.

If the Low range value is equal to 0% and Upper range value is equal to 50% the positioner interpret 4ma like the 0% Request position and the 12ma like 100%.

INPUT SIGNAL : Calibrate 4mA

Read the actual value of the input current and assume it like 4ma value.

CAUTION

Be sure that you are supplying the positioner with a stable, real 4ma.

INPUT SIGNAL : Calibrate 20mA

Read the actual value of the input current and assume it like 20ma value.

Change Description

Each channel can have a description used to identify it in an easy way.



USER MANUAL SmarTrak (ST2)



INPUT CHAR :

The Characterization specify the relationship between the Input signal and the Request Position.

Selecting 'Customer' you have the chance to draw a specific characterization curve.

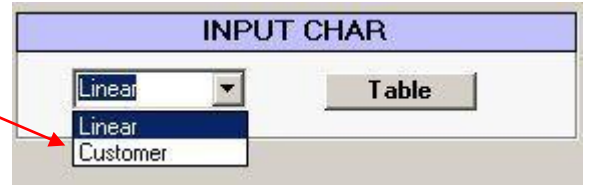
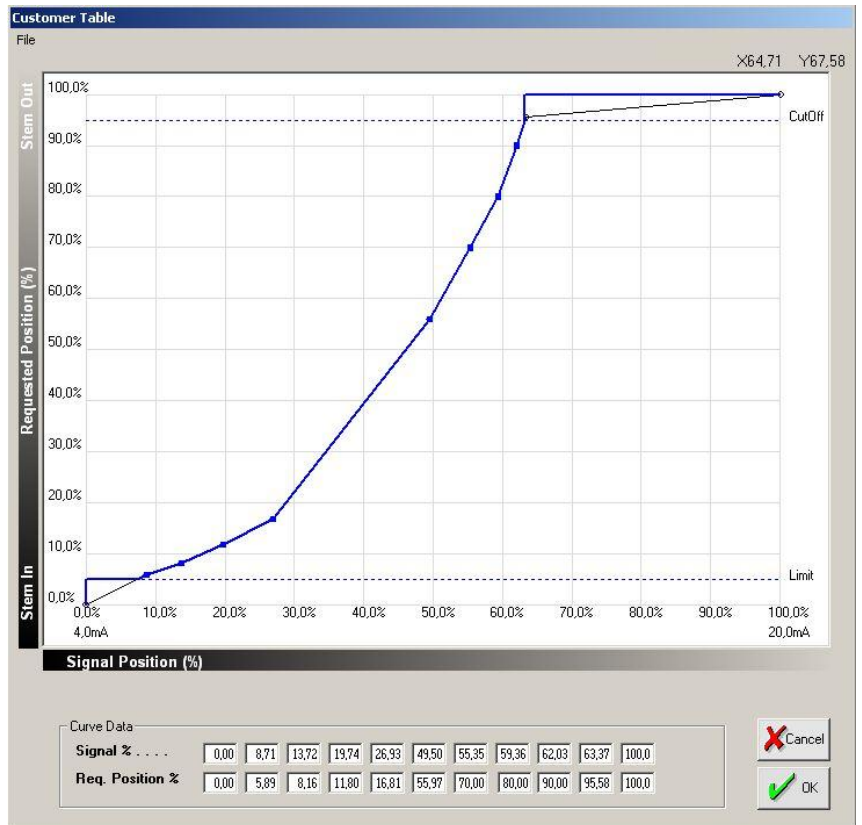

Table button :

Open the Transfer Function Curve window

- The 'Stem In' and 'Stem Out' label in the 'Requested position' axis show the effect of the '0 Ctrl Signal' and '0 Ctrl Position' selection
- The '4.0ma' and '20.0ma' in the 'Signal Position' show the effect of the 'Split Range' setup
- The effect of 'Limit' and 'CutOff' are showed on the graph
- To 'Send' a 'Customer Curve' to the Positioner press the 'OK' button.
 - You can change a value in the table or click_&_move the dot in the graph
 - Keeping hold the shift key and clicking on two dots, automatically the system make a linear interpolation between these two points.





USER MANUAL SmarTrak (ST2)



Position excess Fail

Selecting this command, it's possible to configure the max admissible position error and warning (difference between the required and the actual position) and the actions to be executed, if these limits are exceeded.

- **Mode** : configure the action that will be taken when the error happens.
- **Warning Tolerance** : it's possible to set the max error position value (tolerance) that cause a warning.
- **Warning Time** : In case of warning condition, this parameter defines the waiting time before the alarm is activated.
- **Error Tolerance** : it's possible to set the max error position value (tolerance) that cause an error.
- **Error Time** : In case of error condition, this parameter defines the waiting time before the alarm is activated.

POSITION EXCESS FAIL			
Mode	<input type="text" value="Off"/>		
	Tolerance	Time	
Warning	<input type="text" value="10,0"/> [%]	<input type="text" value="10"/> [sec]	
Error	<input type="text" value="10,0"/> [%]	<input type="text" value="10"/> [sec]	

To set the value, double click on the corresponding cell, click the option and press "OK" to confirm it or "CANCEL" to exit.

Signal Fail

This command allows to configure the minimum and maximum admissible inlet signal (mA), the actions to be executed if these limits are reached and the error clearing condition.

Mode : The first line allows to configure the action to be executed in case of an out of range or fail signal. To set the value, double click on the corresponding cell, click the option and press "OK" to confirm it or "CANCEL" to exit.

Ack : The end mode option configures the action to be executed at the end of the error conditions. The available options are:

- **AUTO** Automatic return to normal working condition without waiting for confirmation.
- **WAIT ACK** A confirmation is required before returning to normal working condition.
- **WAIT NOERR** Automatic return to normal working condition only if all.

SIGNAL FAIL			
Mode	<input type="text" value="Off"/>	Ack	<input type="text" value="Auto"/>
	min	max	
Limits [mA]	<input type="text" value="3,0"/>	<input type="text" value="22,0"/>	
Position	<input type="text" value="0,0"/> [%]		

Position :

This function is active only if the "Spool" selection has been made for the "Error mode" option; by this function it's possible to define the actuator position in case of signal fail. The value of the position (expressed in percentage of the stroke) can be adjusted between -10 and 110% of the stroke.

Probe Fail

Mode : The first line allows to configure the action to be executed in case of an out of range or fail of the probe. To set the value, double click on the corresponding cell, click the option and press "OK" to confirm it or "CANCEL" to exit.

PROBE FAIL	
Mode	<input type="text" value="Off"/>
Ack	<input type="text" value="Auto"/>

Ack : The end mode option configures the action to be executed at the end of the error conditions. The available options are:

- **AUTO** Automatic return to normal working condition without waiting for confirmation.
- **WAIT ACK** A confirmation is required before returning to normal working condition.
- **WAIT NOERR** Automatic return to normal working condition only if all.



USER MANUAL

SmarTrak (ST2)



HART panel

HART PARAMETERS

Tag :

The Tag is a 8 character label assigned by the end user based on the location and use of the field device. It's a 8 character (6 byte) Packed ASCII string used to identify the field device. The term originated when physical tags were attached to instruments for this purpose.

Date :

The date is represented by three 8-bit binary unsigned integers representing, respectively, the day, month and year (minus 1900). It's a date code, used by the Master for record keeping (e.g. last or next calibration date).

Descriptor :

The Descriptor is a 16 character (12 byte) Packed ASCII string used by the Master for record keeping. The default value is a blanked string, 16 bytes long.

Message :

The Message is a 32 character (24 byte) Packed ASCII string used by the Master for record keeping. The default value is a blanked string, 32 bytes long.

Polling address:

In the HART Protocol, the polling address is an integer used to identify the field device. It is used to construct the Short Frame Address. The Polling Address is set to 0 in point to point installations.

Dev. ID :

This number is different for every device manufactured with a given Manufacturer ID and Device Type.

HART Protocol

Show some communication parameters used for debug.

HART Communication

Hart Mode :

'Time management' and 'Time management (performance)' are two different way to manage the Hart modem. If you have experience of communication problems try to change this option.

HART PARAMETERS		HART COMMUNICATION	
Tag	STID&FT	Date	01/01/2000
Descriptor		HART Mode	Time Management
Message			
Polling Address	0	Dev. ID	1
Poll Device			
HART PROTOCOL			
Long Frame Address:	D982000001		
Command:	33	Response Code:	00
Error Code:	00	Device Status:	40



The Graph window

Event Line : moving with the mouse on the line, specification about the event are showed (i.e. Ch1 TRIP1)

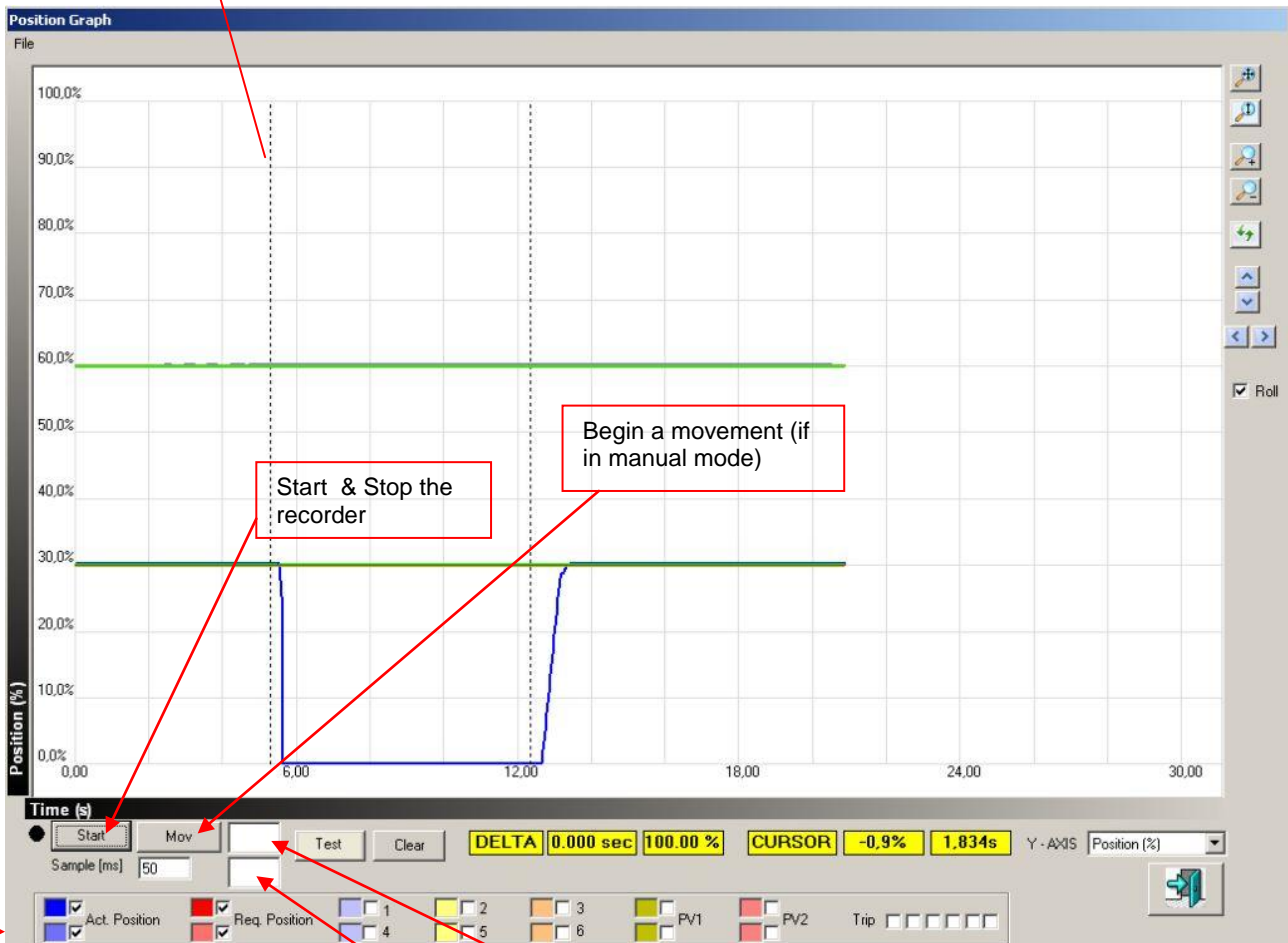

Start & Stop the recorder

Begin a movement (if in manual mode)

Channel 2 information selector.

Channel 1 information selector.

Specify the CH1 Required position for a manual movement

Specify the CH2 Required position for a manual movement

Double Click on the painted area to change the color.



The Graph Menu

File : Save Image

Save the actual showed picture like a .bmp file

File : Save Snapshot

Save the actual picture in binary file

File : Load Snapshot

Load the graph stored in a binary file

File : Load History File

Load an History file previously stored in a SD card
Opening the file you can select the portion of the graph that you want to see.
In the right-bottom side of the graph appear a selection box with a list of the records available. Select the desired one and click Load to open.

**File : Convert History File**

Open an History file previously stored in a SD card in a .csv file. It is possible open the file with a spreadsheet like Excel and analyze the data.



STI Advanced Panel

This panel is for expert user only.

Inserting the password '23456' the 'STI' button appear in the top left part of the main window.

Pressing the 'STI' button different windows are available.

Probe (STI Advanced Panel)

For each channel is possible :

- Select the type of the probe
 - o Micropulse
 - o 4-20mA
- Check the actual values
- Verify calibration limits

It is possible to change the type of the probe only if the channel is NOT calibrated.

	CH 1	CH 2
Probe Type	MicroPulse	MicroPulse

	CH 1	CH 2
Act Position (%)	0.30	0.05
Probe	3927	4157

	CH 1	CH 2
ActLimInf	3916	4155
ActLimSup	6542	11952



USER MANUAL

SmarTrak (ST2)



Proportional valve (STI Advanced Panel)

The P.V.Type allow the selection of different types of proportional solenoid valve.

Choosing a value the PWM min and max limits are loaded.

If it is needed to use a proportional valve not listed, it is possible to evaluate the min and max value with manual control and then put the value in the min and max field (select calibration type equal to 'Manual' to disable the self evaluation of the current limits).

FB Current Value :

Show the current (in ampere) that flow in the solenoid valve.

Manual control :

(only if the channel is not calibrated)

Drive manually one proportional valve.

Write a value in the field (between the PWMmin and max values) and press the '+' or '-' button to energize the proportional valve in one direction or in the other).

Check the current that energize the solenoid in the 'FB Current Value' field.

Calibration type :

Manual : during calibration only the minimum current needed to move the valve is evaluated

Autosearch : during calibration not only the minimum current is evaluated but also the PWM needed to reach the nominal current value (if you select an ATOS 12V 2,2A the ST2 search for the PWM that is necessary to drive 2,2A in the coil).

The screenshot shows the 'P. VALVE' configuration screen. It is divided into several sections:

- CALIBRATION DATA:** A table with columns for CH 1 and CH 2.

	CH 1	CH 2
P. V. Type	Rexroth 2.5A	Atos 12V 2.2/2
PWM_min	900	950
PWM_Max	2000	3500
PWM_1A	0	0
P 1		
PWM_min	1100	900
PWM_Max	2000	3500
PWM_1A	0	0
P 2		
- MANUAL CONTROL:** A section for manual PWM control. It includes a 'PWM Register' with '+' and '-' buttons for CH 1 and CH 2, and a 'Calibration Type' dropdown menu set to 'Manual'.
- FB CURRENT VALUE:** A section showing current values for PV1 and PV2 for both channels.

	CH 1	CH 2
Curr. PV1	1,38	0,95
Curr. PV2	0,02	0,03
- CONTROL VALUES:** A section showing PWM and Perc. values for both channels.

	CH 1	CH 2
PWM	-1998	-1159
Perc.	-10000	-1000



USER MANUAL

SmarTrak (ST2)



SOV (STI Advanced Panel)

Feedback :

The 'SET' column show if the ST2 want to energize a specific solenoid valve(The yellow led is turned 'ON').

The 'F.back' column show if a solenoid valve is connected without errors (the GREEN led is turned 'ON' if a solenoid valve is recognized).

'Pw Red.'

Select the power level for the SOV.

A solenoid valve is energized with the full power (24V=). After 1 second the power applied is equal to the percentage specified in the field. Reducing the power (for example at 80%) the life of a solenoid valve is longer, the heating is reduced and the total power used for the device is less. In case of long cables between ST2 and SOV it is important to check that the voltage on the coil is enough).

'Use Feedback Control'

Checking the box if an error happens on a SOV it is managed by the ST2.

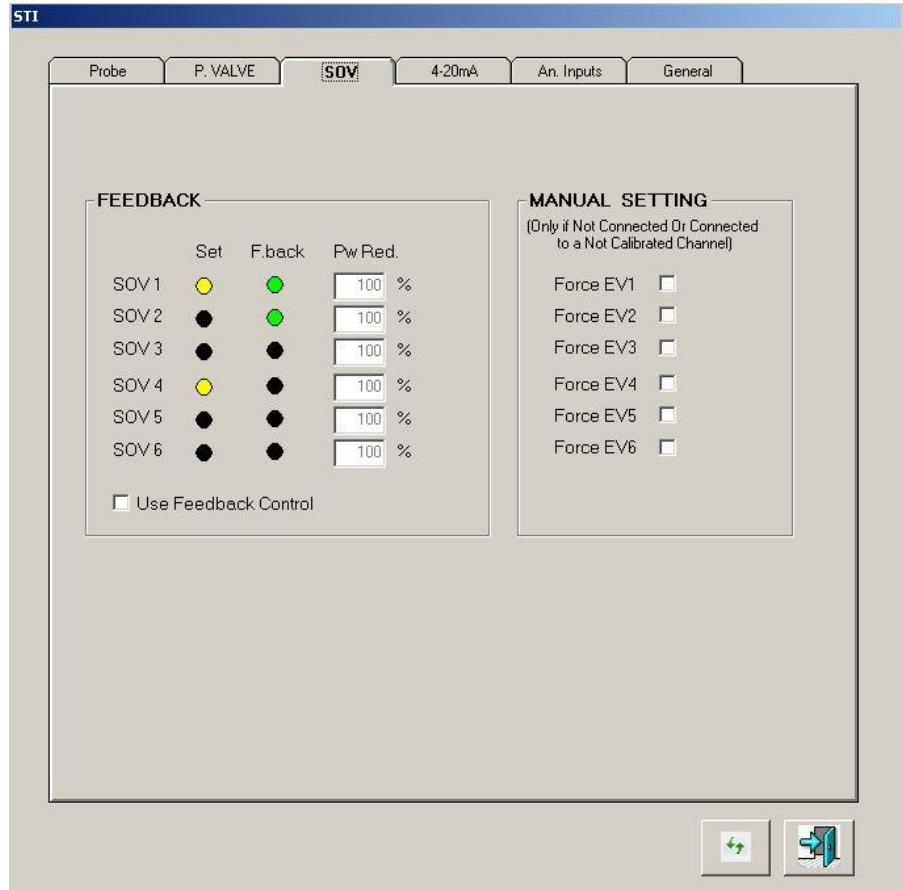

Manual Settings

If the SOV is not assigned to a calibrated channel it is possible to turn ON and OFF it.



USER MANUAL

SmarTrak (ST2)



4-20mA (STI Advanced Panel)

4-20mA INPUT :

It is possible to check the calibration limits and the current value

It is possible to calibrate the 4-20mA input in the standard channel CFG panel.

4-20mA OUTPUT :

It is possible to calibrate the 4mA and the 20mA signal level of each output.

The screenshot shows the STI configuration interface for the 4-20mA input. The interface is divided into several sections:

- 4-20 mA INPUT - CALIBRATION DATA:** A table with columns for CH 1 and CH 2.

	CH 1	CH 2
Conv4mA	12177	12177
Conv20mA	60877	60877
- 4-20 mA INPUT - ACTUAL VALUES:** A table with columns for CH 1 and CH 2.

	CH 1	CH 2
A/D Converter	26	9
mA	0,01	0,00
- 4-20 mA OUTPUT - CALIBRATION DATA OUTPUT 1:** Fields for Conv4mA (792) and Conv20mA (4011), each with a 'Start Calibration' button. An 'Actual' field shows 0.
- 4-20 mA OUTPUT - CALIBRATION DATA OUTPUT 2:** Identical fields to Output 1, with 'Actual' field showing 0.

At the bottom right, there are two icons: a green refresh icon and a blue arrow icon.



USER MANUAL SmarTrak (ST2)



An. Inputs (STI Advanced Panel)

For each analog input (6 channels are available) it is possible:

- Calibrate the 4mA limit
- Calibrate the 20mA limit
- Assign a Name of 4 digit (for example 'Pi')
- Assign a label like measuring unit (for example 'bar')
- Specify the relationship between the 4-20mA signal and the measured value (for example: 4mA=0bar, 20mA=400bar)

The screenshot displays the 'An. Inputs' configuration window in the STI software. It is divided into two main sections: 'AI1-3' and 'AI4-6'. Each section contains three input configurations. The 'Pi' configuration (AI1-3) shows calibration values for 4mA (761) and 20mA (3823), with a name 'Pi' and unit 'bar'. The 'Toil' configuration (AI4-6) shows calibration values for 4mA (761) and 20mA (3823), with a name 'Toil' and unit '°C'. The 'Pa' configuration (AI4-6) shows calibration values for 4mA (761) and 20mA (3823), with a name 'Pa' and unit 'psi'. Each configuration also includes 'Actual Value' fields for AD-Conv and Act. Value. The interface includes a top menu bar with 'Probe', 'P. VALVE', 'SOV', '4-20mA', 'An. Inputs', and 'General'. At the bottom right, there are two icons: a green arrow and a blue arrow pointing to a document.



USER MANUAL

SmarTrak (ST2)



General (STI Advanced Panel)

'Erase calibration' :

For each channel it is possible to remove the calibration

'Set as default' :

Save the actual configuration data like a default in the ST2 memory.

Reset to default':

Load a stored configuration. It is possible to select a partial set of data to load.

'Upload' :

Send the actual data in the Remote Control to the ST controller. It is possible to select a partial set of data to load.

'Reset factory default' :

Reset the ST2 to the factory default data.

'Save parameters' :

Start to save the parameters that are in RAM in the eeprom (this action is only for diagnostic, the parameters are saved automatically when changed in the RemoteControl interface.

'Memory test' :

With the 'check memory' button it is possible to check if the stored configuration is equal to the one used. This option is for diagnostic purpose

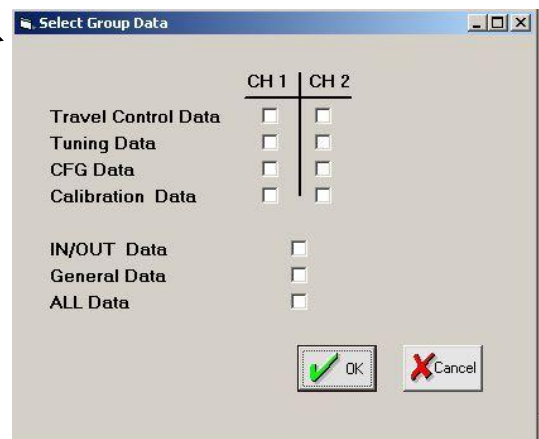
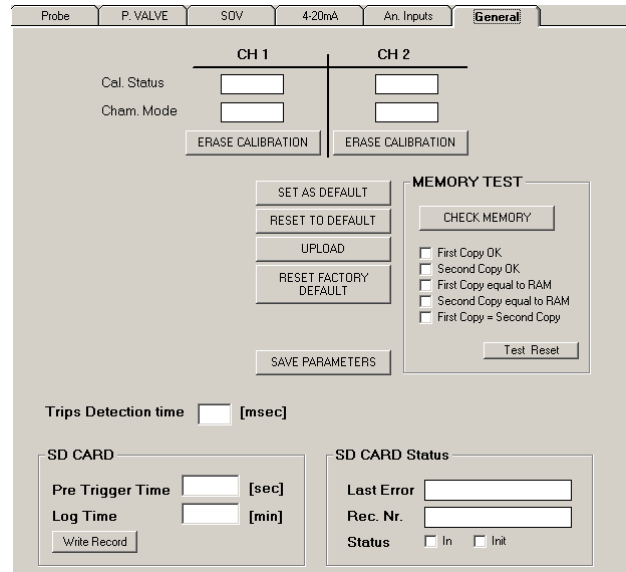

Trips detection time:

Specify the delay (filter) in milliseconds for TRIP detection.

SD CARD : Pre Trigger Time

Position of the event in the 20 seconds snapshot. Selecting 8 sec the snapshot starts 8 second before the event.

SD CARD : Log Time

Period between two consecutive record in the Periodic Log.



The Menu

Menu : File

Load:

Load a saved set of parameters in the RC interface

Save :

Save the current set of parameters in a .qtp file

Report :

Make a document in .rtf format with the actual parameters (It is similar to the Save command but the file format is compatible with editor software)

Exit :

Close the application

Menu : Device

Download

It is the same of the quick  button



USER MANUAL

SmarTrak (ST2)



Example of Configuration Report

SYSTEM REPORT

SYSTEM INFORMATION		
Date (PC)	08/20/2010 09.02.00	
Date (SmarTrak)	08/20/2010 08:03:33	
Channel 1 Description	Channel 1	
Channel 2 Description	Channel 2	
Device Unique ID	01D1FCC41100009F	
DSP SW Version	9,09	
Temperature	26,0	
	Channel 1	Channel 2
Calibration Status	Not Calibrated	Calibrated
Service State	Out Of Service	Manual

TRAVEL CONTROL		
Parameter	Channel 1	Channel 2
0 Ctrl Signal	Stem In	Stem In
0 Position	Stem In	Stem In
Low Limit	5,0 %	5,0 %
Low Limit Mode	Off	Off
High Limit	95,0 %	95,0 %
High Limit Mode	Off	Off

TUNING		
Parameter	Channel 1	Channel 2
Kp IN	10,0	0,2
Kp Out	10,0	0,2
Stroke Time IN	0,0 sec	0,0 sec
Stroke Time OUT	0,0 sec	0,0 sec
Approach IN	0	0
Approach OUT	0	0
Dead Band (%)	0,50 %	0,50 %

FAIL TRIP SETTINGS				
Trip Number	Mode Ch1	Mode CH2	Ack	"On" Status
1	Off	Safety Shut Down 4	Auto	Energized
2	Off	Off	Auto	Energized
3	Off	Off	Auto	Energized
4	Off	Off	Auto	Energized
5	Off	Off	Auto	Energized
6	Off	Off	Auto	Energized



USER MANUAL

SmarTrak (ST2)



SOV ASSIGNEMENT	
SOV Number	Assigned to:
1	Channel 2
2	Channel 2
3	Channel 2
4	Disconnected
5	Disconnected
6	Disconnected

SOV STATUS						
<i>Channel 1</i>						
	SOV 1	SOV 2	SOV 3	SOV 4	SOV 5	SOV 6
Running	--	--	--	--	--	--
Safety Shut Down 1	--	--	--	--	--	--
Safety Shut Down 2	--	--	--	--	--	--
Safety Shut Down 3	--	--	--	--	--	--
<i>Channel 2</i>						
	SOV 1	SOV 2	SOV 3	SOV 4	SOV 5	SOV 6
Running	On	Off	Off	--	--	--
Safety Shut Down 4	Off	Off	Off	--	--	--
Safety Shut Down 5	On	On	Off	--	--	--
Safety Shut Down 6	Off	Off	Off	--	--	--

BOOSTER CONFIGURATION						
<i>Channel 1</i>						
	Mode	Target	Act. Tresh	Dis. Tresh.	Use PV	Trip
Safety Shut Down 1	No	Stem In	50,00	20,00	Yes	Trip 1
Safety Shut Down 2	No	Stem In	50,00	20,00	Yes	Trip 1
Safety Shut Down 3	No	Stem In	50,00	20,00	Yes	Trip 1
<i>Channel 2</i>						
	Mode	Target	Act. Tresh	Dis. Tresh.	Use PV	Trip
Safety Shut Down 4	With Enable	Stem Out	50,00	5,00	Yes	Trip 1
Safety Shut Down 5	With Enable	Stem In	50,00	5,00	No	Trip 1
Safety Shut Down 6	No	Stem In	50,00	20,00	Yes	Trip 1



USER MANUAL

SmarTrak (ST2)



DIGITAL OUTPUT CONFIGURATION

	OUT 1	OUT 2	OUT 3
Waiting Ack CH 1	Off	Off	Off
Waiting Ack CH 2	Off	Off	Off
Out Of Service CH1	Off	Off	Off
Out Of Service CH2	Off	Off	Off
Trip 1	Off	Off	Off
Trip 2	Off	Off	Off
Trip 3	Off	Off	Off
Trip 4	Off	Off	Off
Trip 5	Off	Off	Off
Trip 6	Off	Off	Off
General Error CH 1	Off	Off	Off
General Error CH 2	Off	Off	Off
Signal Fail CH 1	Off	Off	Off
Signal Fail CH 2	Off	Off	Off
Position Excess Error CH 1	Off	Off	Off
Position Excess Error CH 2	Off	Off	Off
Position Excess Warning CH 1	Off	Off	Off
Position Excess Warning CH 2	Off	Off	Off
Probe Error CH 1	Off	Off	Off
Probe Error CH 2	Off	Off	Off

ANALOG OUTPUTS CONFIGURATION

OUT A	Off
OUT B	Off

CHANNELS CONFIGURATION

Parameter	Channel 1	Channel 2
Split Range Low	4,0 mA	4,0 mA
Split Range High	20,0 mA	20,0 mA
Position Excess Error Fail Mode	Off	Off
Position Excess Error Tolerance	10,0 %	10,0 %
Position Excess Error Time	10 sec	10 sec
Position Excess Warning Tolerance	10,0 %	10,0 %
Position Excess Warning Time	10 sec	10 sec
Signal Fail Mode	Off	Off
Signal Fail Ack	Auto	Auto
Signal Fail Min Value	3,0 mA	3,0 mA
Signal Fail Position	0,0 %	0,0 %
Probe Fail Mode	Safety Shut Down 1	Safety Shut Down 4
Probe Fail Ack	Wait Ack	Wait Ack
Input Char	Linear	Linear



USER MANUAL SmarTrak (ST2)



CUSTOMER CURVE DATA

<i>Channel 1</i>		<i>Channel 2</i>	
Signal %	Req. Pos %	Signal %	Req. Pos %
0,00	0,00	0,00	0,00
10,00	10,00	10,00	10,00
20,00	20,00	20,00	20,00
30,00	30,00	30,00	30,00
40,00	40,00	40,00	40,00
50,00	50,00	50,00	50,00
60,00	60,00	60,00	60,00
70,00	70,00	70,00	70,00
80,00	80,00	80,00	80,00
90,00	90,00	90,00	90,00
100,00	100,00	100,00	100,00



USER MANUAL

SmarTrak (ST2)



ADVANCED PARAMETERS

PROBE PARAMETERS		
	Channel 1	Channel 2
Probe Type	MicroPulse	4-20mA
Probe Limit Inf.	4160	735
Probe Limit Sup.	11988	3473

PROPORTIONAL VALVE		
	Channel 1	Channel 2
Valve Type	Atos 12V 2.2/2.6A	Atos 12V 2.2/2.6A
Side 1		
PWM_min	1000	1100
PWM_Max	3500	3500
PWM_1A	0	0
Side 2		
PWM_min	1000	1100
PWM_Max	3500	3500
PWM_1A	0	0

SOLENOID VALVE						
	SOV 1	SOV 2	SOV 3	SOV 4	SOV 5	SOV 6
PWM Reduction	100%	100%	100%	100%	100%	100%
Use Feedback Control	Off					

INPUT 4-20 mA		
	Channel 1	Channel 2
AD Converter at 4 mA	12177	12177
AD Converter at 20 mA	60877	60877

OUTPUT 4-20 mA		
	OUT 1	OUT 2
AD Converter at 4 mA	792	792
AD Converter at 20 mA	4011	4011

USER ANALOG INPUTS	
Analog Input 1	
Name	AI1
Measure Unit	
AD Converter at 4 mA	761
AD Converter at 20 mA	3823
Value at 4 mA	0,0
Value at 20 mA	400,0
Analog Input 2	
Name	AI2
Measure Unit	
AD Converter at 4 mA	761



USER MANUAL

SmarTrak (ST2)



AD Converter at 20 mA	3823
Value at 4 mA	0,0
Value at 20 mA	400,0
Analog Input 3	
Name	AI3
Measure Unit	
AD Converter at 4 mA	761
AD Converter at 20 mA	3823
Value at 4 mA	0,0
Value at 20 mA	400,0
Analog Input 4	
Name	AI4
Measure Unit	
AD Converter at 4 mA	761
AD Converter at 20 mA	3823
Value at 4 mA	0,0
Value at 20 mA	400,0
Analog Input 5	
Name	AI5
Measure Unit	
AD Converter at 4 mA	761
AD Converter at 20 mA	3823
Value at 4 mA	0,0
Value at 20 mA	400,0
Analog Input 6	
Name	AI6
Measure Unit	
AD Converter at 4 mA	761
AD Converter at 20 mA	3823
Value at 4 mA	0,0
Value at 20 mA	400,0

GENERAL PARAMETERS		
	<i>Channel 1</i>	<i>Channel 2</i>
Camera Mode	Normal	Inverted
SD CARD		
Pre Trigger Time	8,0 sec	
Log Time	60 min	
TRIPS		
Trips Detection Time	40 mSec	



USER MANUAL SmarTrak (ST2)



Menu : Password

Login

It is the same of the quick



button.

Change

To change the password

Menu : ? Info

Information panel with different sw version data.

“Device Unique ID” is an hardware identifier used to identify a specific electronic hw.

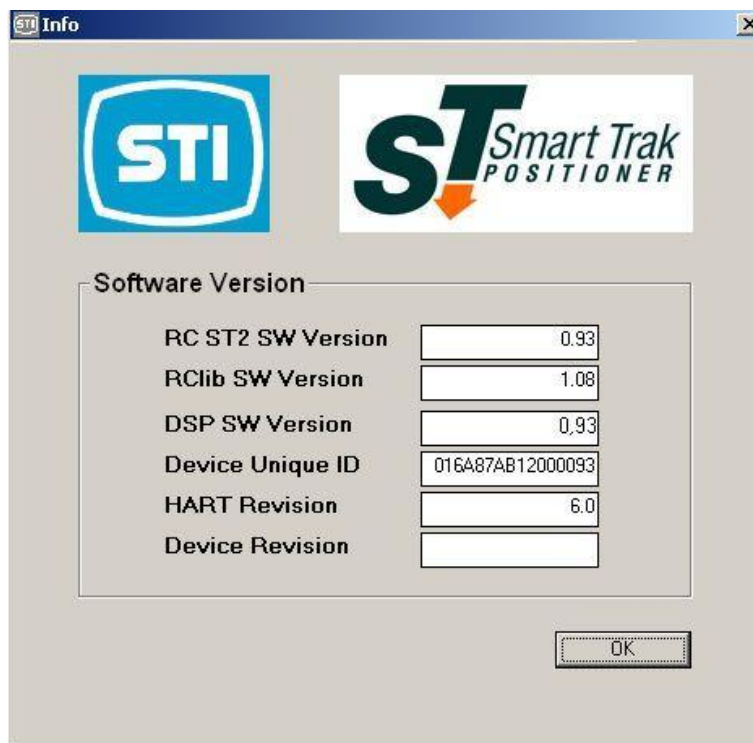



USER MANUAL SmarTrak (ST2)



Electrical connections:

Application example :

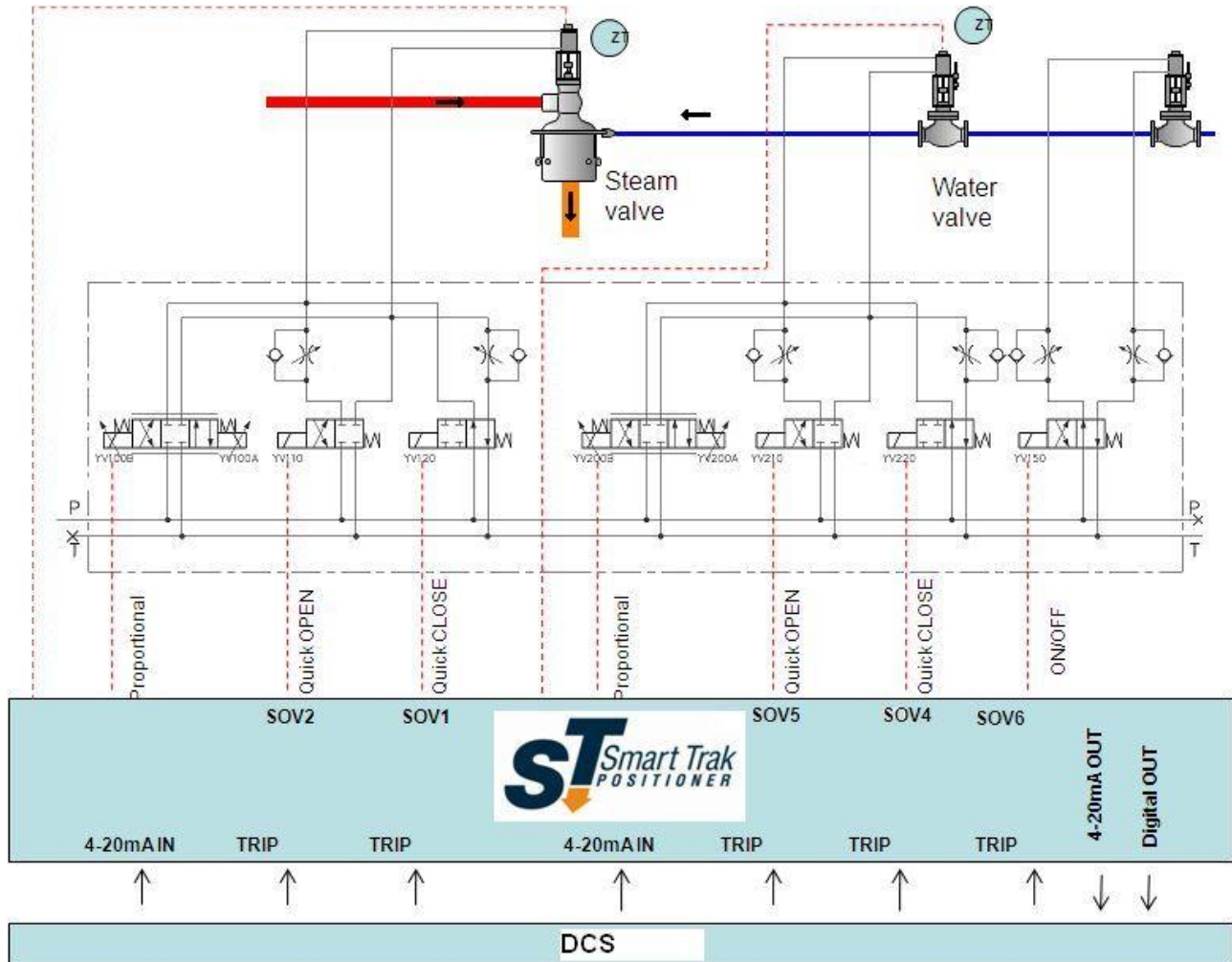



Terminal Board : wiring specification and electrical rating

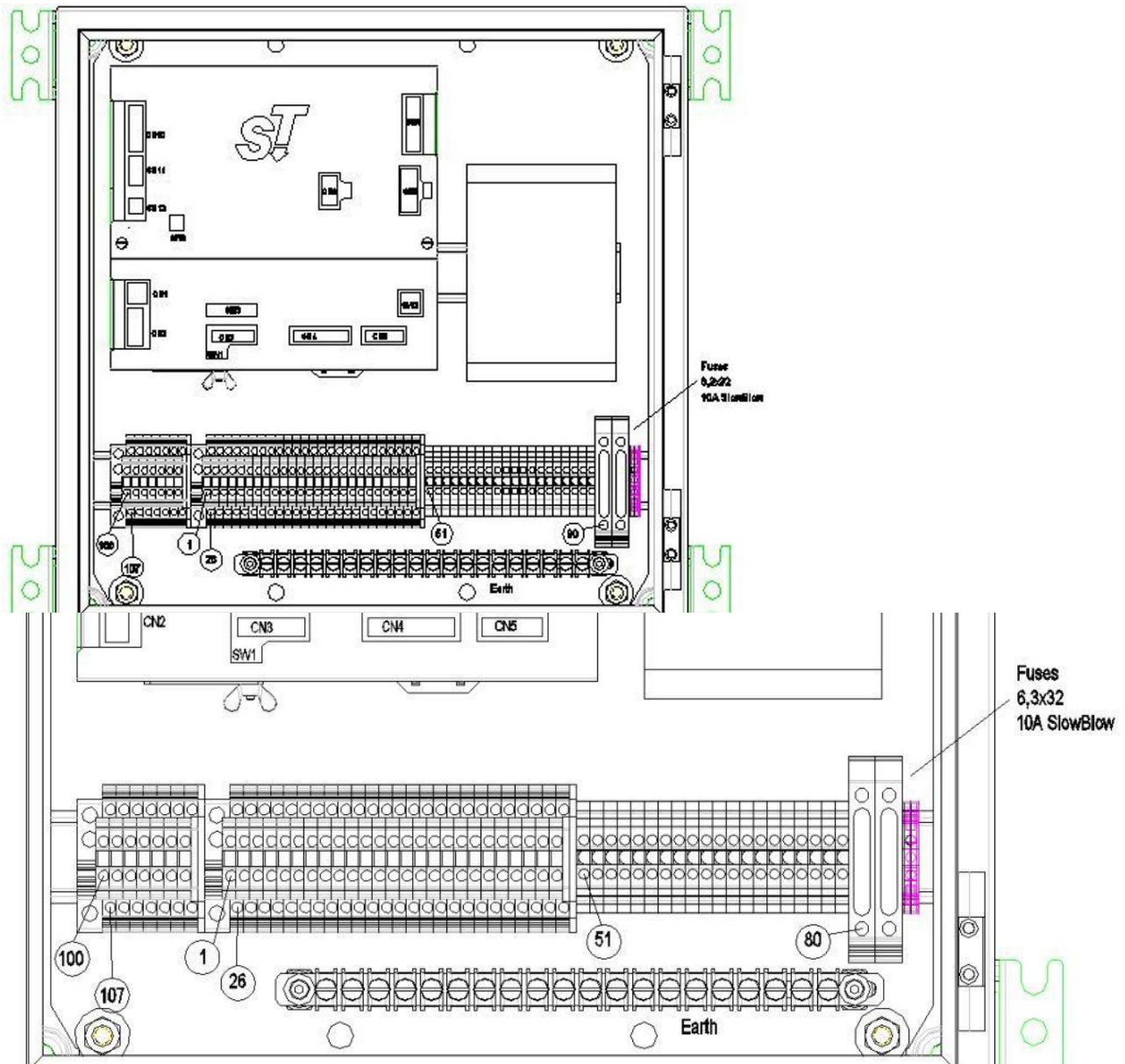



USER MANUAL

SmarTrak (ST2)



Terminal board from 1 to 50 and from 100 to 113 :

Phoenix Contact UKK3 (2770011)
Double-level terminal block with a screw connection, cross section: 0.2 mm² - 2.5 mm², AWG: 28 – 12
Rated surge voltage 6 kV
Nominal current IN 32 A
Nominal voltage UN 500 V
Type of connection Screw connection
Tightening torque, min 0.5 Nm
Tightening torque max 0.6 Nm

Terminal board from 51 to 70

Phoenix Contact UK 2,5 N (3003347)
Universal terminal block with screw connection, cross section: 0,2- 2.5 mm², AWG: 24- 12
Rated surge voltage 8 kV
Nominal current IN 24 A
Nominal voltage UN 800 V
Type of connection Screw connection
Tightening torque, min 0.6 Nm
Tightening torque max 0.8 Nm

Terminal board from 80 to 81

Phoenix contact UK 6,3-HESI (3004171)
Fuse terminal block for cartridge fuse insert, cross section: 0.5 – 16 mm², AWG: 26 - 8,
Rated surge voltage 6 kV
Fuse G / 6,3 x 32
Nominal current IN 10 A
Nominal voltage UN 500 V (As a fuse terminal block)
Type of connection Screw connection
Tightening torque, min 1.2 Nm
Tightening torque max 1.5 Nm



USER MANUAL

SmarTrak (ST2)



Terminal Board : pinout

Terminal board from 1 to 50

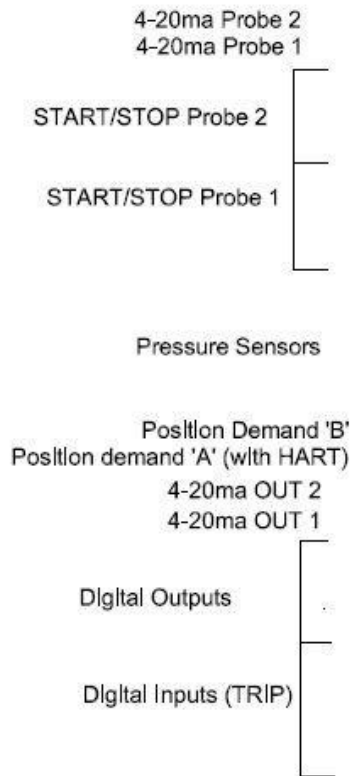

26	4-20ma signal	1	4-20ma signal
27	nSTART/STOP	2	GND
28	nINIT	3	START/STOP
29	+24 Probe	4	INIT
30	nSTART/STOP	5	GND
31	nINIT	6	START/STOP
32	+24 Probe	7	INIT
33	+5SENS_PRESS	8	GNDSENS_PRESS
34	ANALOG_IN6	9	+24SENS_PRESS
35	ANALOG_IN4	10	ANALOG_IN5
36	ANALOG_IN2	11	ANALOG_IN3
37	RX4-20_2-	12	ANALOG_IN1
38	RX4-20_1- (HART)	13	RX4-20_2+
39	TX4-20_2-	14	RX4-20_1+ (HART)
40	TX4-20_1-	15	TX4-20_2+
41	RELE' 3O	16	TX4-20_1+
42	RELE' 2O	17	RELE' 3C
43	RELE' 1O	18	RELE' 2C
44	TRIP1 COM	19	RELE' 1C
45	TRIP6+	20	TRIP6-
46	TRIP5+	21	TRIP5-
47	TRIP4+	22	TRIP4-
48	TRIP3+	23	TRIP3-
49	TRIP2+	24	TRIP2-
50	TRIP1+	25	TRIP1-



USER MANUAL

SmarTrak (ST2)



Terminal board from 51 to 70

ON/OFF valves

Proportional Valves

51	SOV1+
52	SOV1-
53	SOV2+
54	SOV2-
55	SOV3+
56	SOV3-
57	SOV4+
58	SOV4-
59	SOV5+
60	SOV5-
61	SOV6+
62	SOV6-
63	PROP_VALVE_A_1+
64	PROP_VALVE_A_1-
65	PROP_VALVE_A_2+
66	PROP_VALVE_A_2-
67	PROP_VALVE_A_3+
68	PROP_VALVE_A_3-
69	PROP_VALVE_A_4+
70	PROP_VALVE_A_4-

Terminal board from 80 to 82

Power Supply

80	
81	
82	EARTH

AC Power supply :

80 = Line

81 = Neutral

DC Power supply :

80 = Positive input

81 = Negative input

Terminal board from 100 to 113

COMMUNICATION OPTIONAL

107	exp 485 'A'	100	exp 485 'B'
108	exp 485 'Y'	101	exp 485 'Z'
109		102	exp 485 GND
110	CAN 'L'	103	CAN 'H'
111		104	CAN GND
112	EXT DISP 'B'	105	EXT DISP 'A'
113	EXT DISP +24	106	EXT DISP GND



Position Feedback Probe

You can use two different type of position feedback probe :
Micropulse transducers or 4-20mA.

FeedBack PROBE

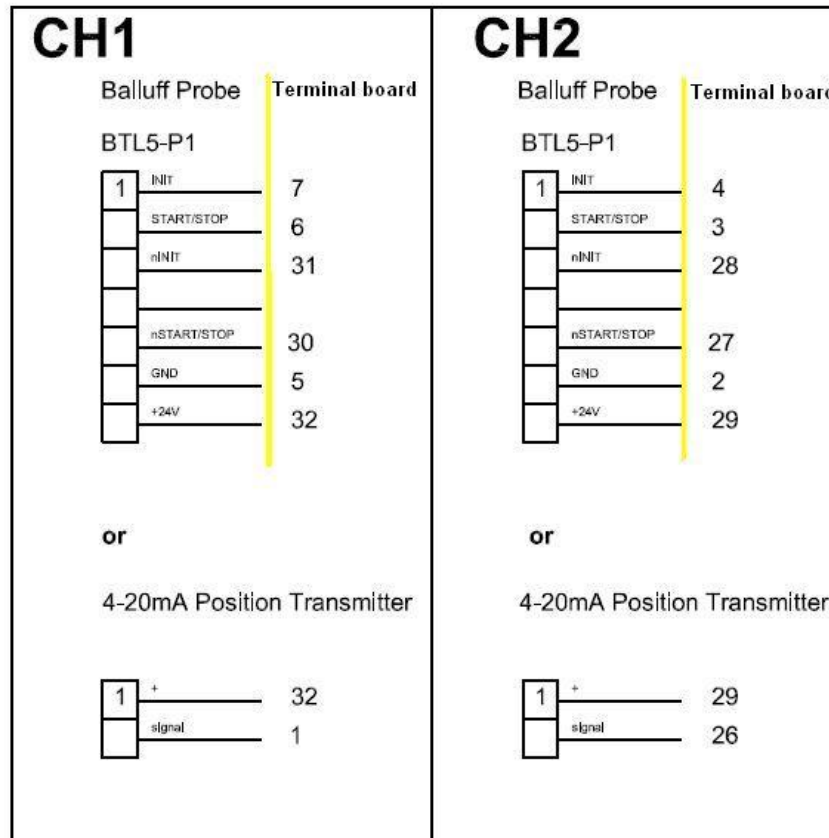

- BTL5-P1 Balluff Micropulse transducer (or equivalent)
 - The probe is powered at 24V=.
 - Shield of the cable can be connected in the ST2 earth connection bar. Depending on the quality of the earth connection in the field could be necessary remove the earth connection of the probe or connect it at the gnd terminal board.
- 4-20mA signal transmitter (for example STI2030)
 - The position transmitter is energized with a 24V= power supply.
 - The measurement resistor inside ST2 is equal to 120 ohms.



Analog Input (pressure sensors)

6 input for 4-20mA (or 0-5V) are available.

PRESSURE TRANSMITTER

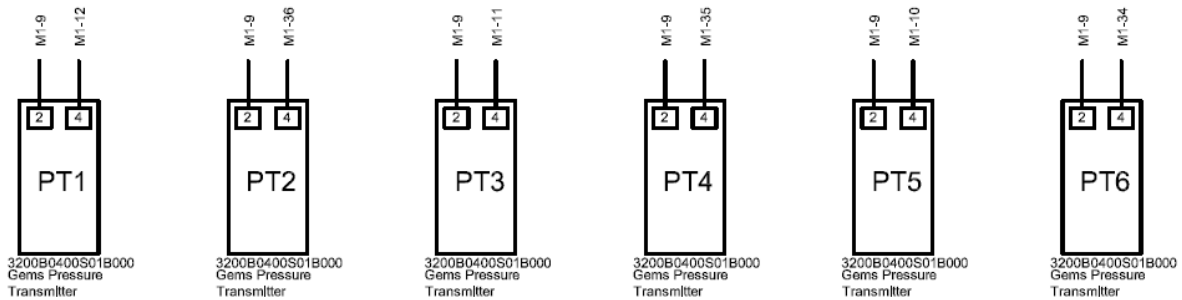

SW3 dip switch select if the input is for 0-5V (dip in OFF position) or 4-20mA (dip in ON position).
SW3_1 is for Analog IN1, SW3_2 is for Analog IN2 and so on.

4-20mA input (preferred solution) :

Terminal board 9 : +24V= for sensor excitation

Terminal pin 12, 36, 11, 35, 10, 34 : input signal from the sensor

Burden resistor : 227 ohms

Analog Input 0-5V :

Terminal board 33 : 5V to energize the sensors (max 100mA)

Terminal board 8 : GND

Terminal pin 12, 36, 11, 35, 10, 34 : input signal from the sensor

Resolution : 12 bits

Sampling rate : 1KHz with moving average filter.

Isolation : Analog input are not isolated and designed for local use. Take care of electrical noise effect.



USER MANUAL SmarTrak (ST2)



4-20mA IN : Request position

CH1 : Terminal board 14 (+) and 38 (-) . With HART communication channel

CH2 : Terminal board 13 (+) and 37 (-)

Burden resistor : 474 ohms

Resolution : 16 bits

Sampling Rate : 1KHz with filter

Hardware LowPass filter present.

Isolation : the two channels are isolated respect other electronic (microprocessor) and themselves

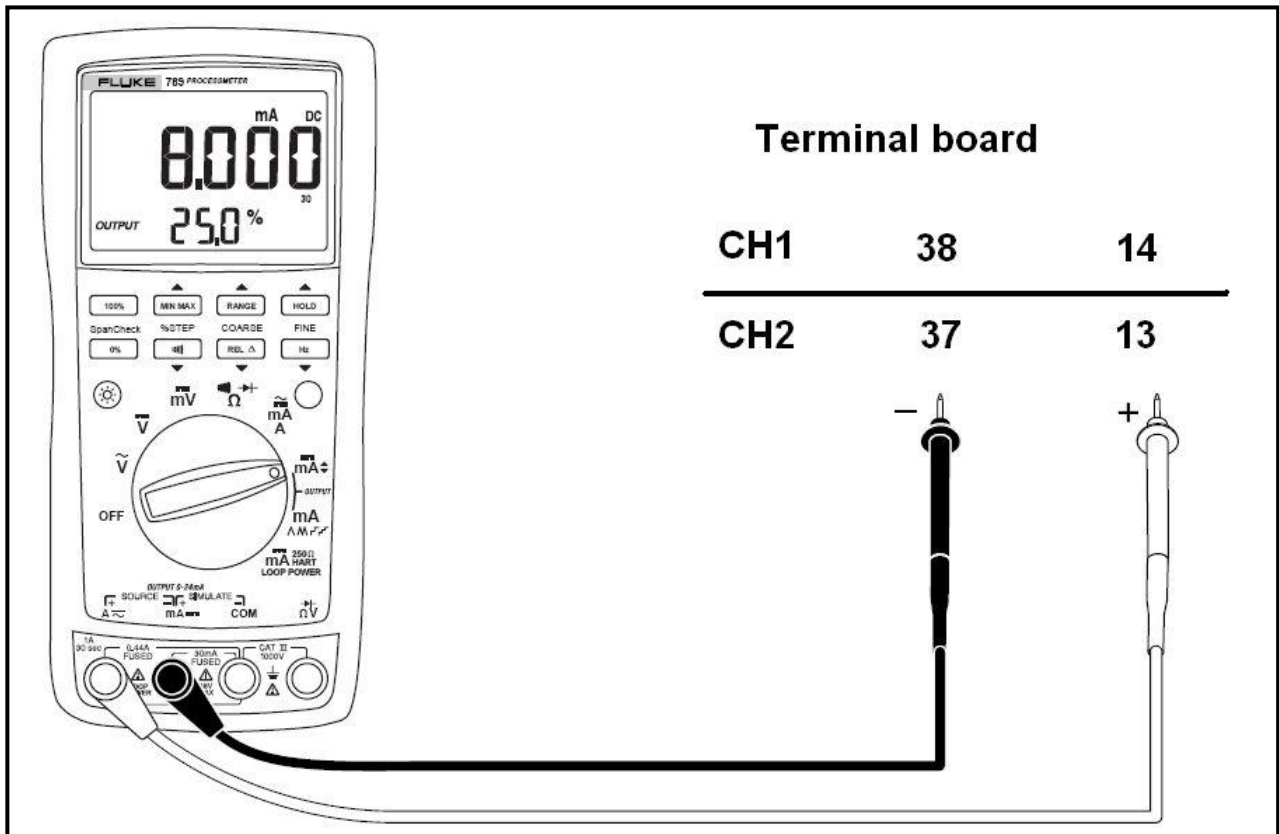



USER MANUAL

SmarTrak (ST2)



4-20mA OUT

Two isolated independent channels are available.

The function is configurable.

The output is energized from the loop.

CH1 : Terminal board 16 (+) and 40 (-) . CH2 : Terminal board 15 (+) and 39 (-)

Output current (nominal) 4-20ma

Burden 750 Ω max (power supply = 24Vdc)

External power supply 24V (12..30V)

Resolution : 12 bits

Refresh frequency : 1KHz

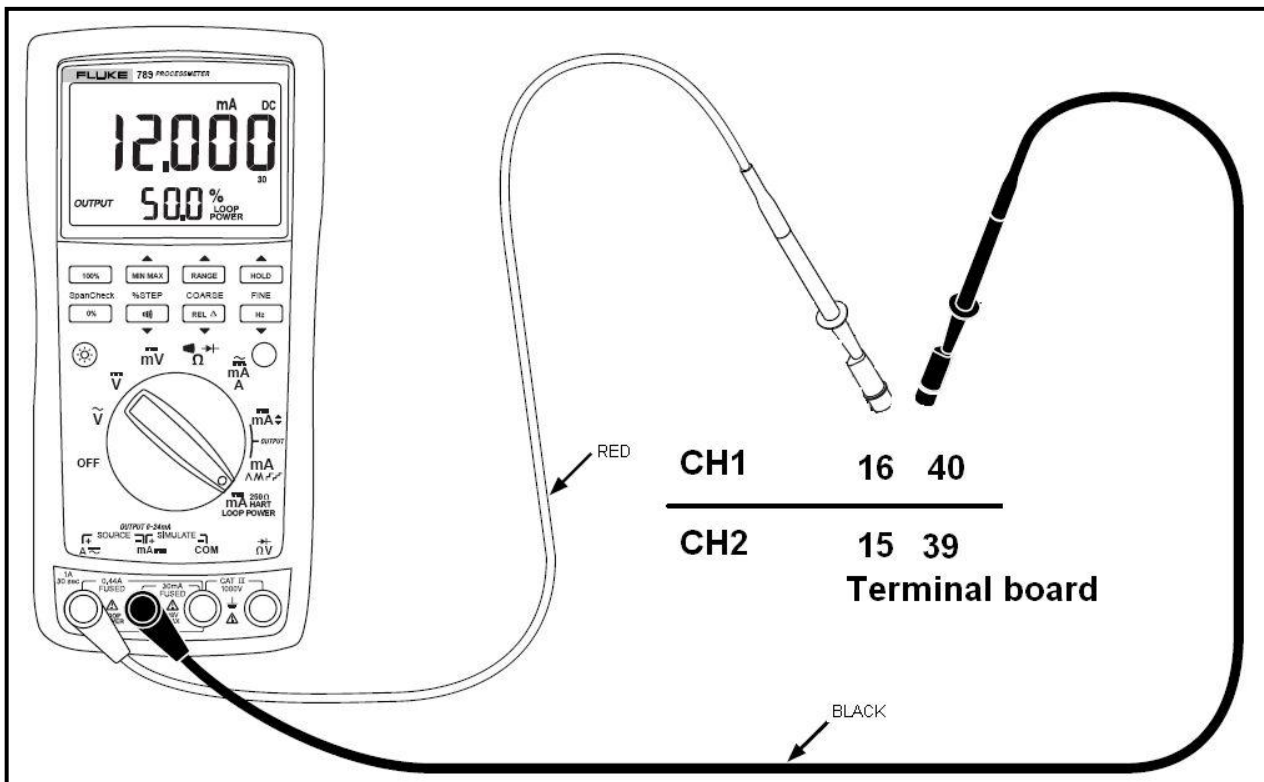



USER MANUAL

SmarTrak (ST2)



Digital output

3 independent digital output is available.

Material	Gold overlay silver alloy
Rating (resistive)	3 A 250 VAC or 3 A 30 VDC
Maximum Carrying Current	5 A
Maximum Switching Power	750 VA, 90 W
Maximum Switching Voltage	270 VAC, 150 VDC
Maximum Switching Current	5 A

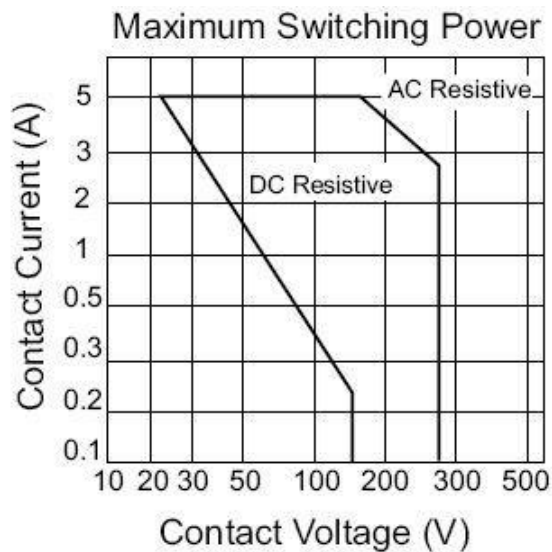

For each digital output the Normally Open contact is available (i.e. DigitalOutput 1 : pin 19 and 43)
When a DigitalOutput is configured the relè is energized (and the contact become closed) when the error condition is false, and is deenergized (and the contact return to open condition) when the error condition is true.



TRIP : Digital Input

6 independent isolated TRIP digital input are available.
Each trip can be driven from a 'free contact' or from a 24V= or 24Vac signal.
SW2 dip switch must be set in a proper way based on the type of driving signal.
Trip function is configurable in the sw.

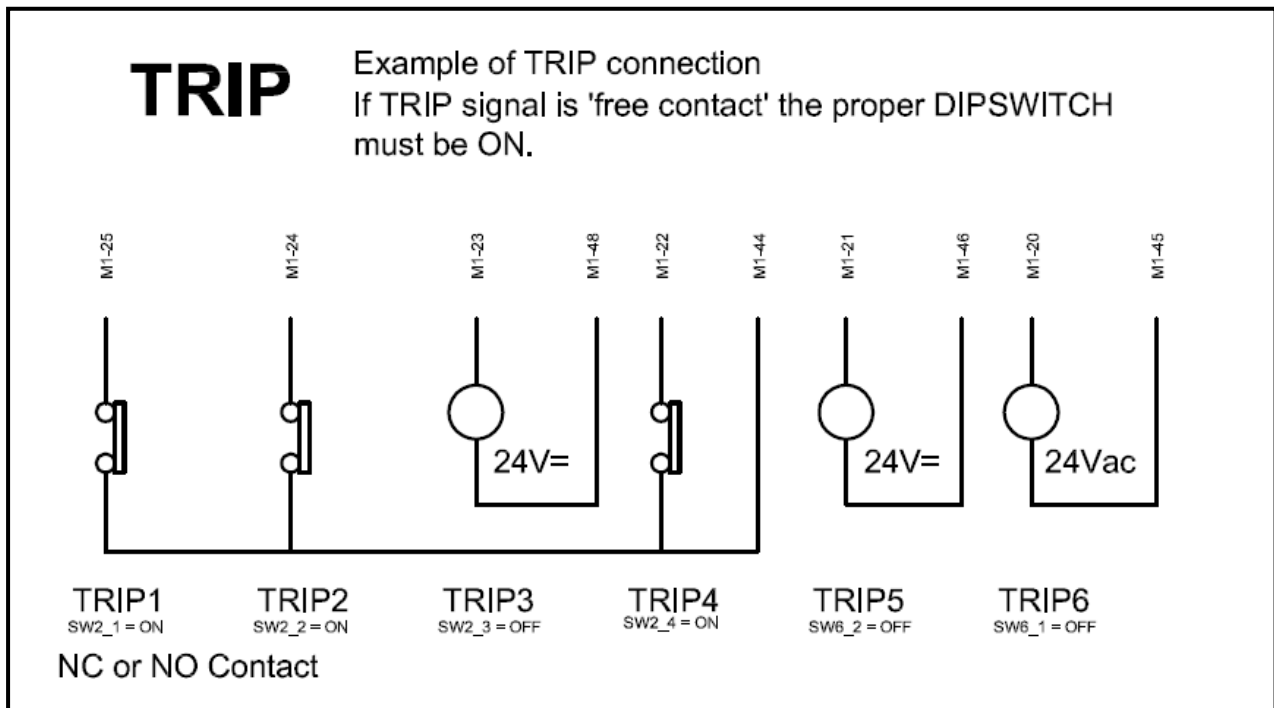

ON/OFF SOV

Up to 6 ON/OFF SOV are available.
Nominal voltage : 24V=
Nominal current : up to 2A (continuous mode, ambient = 70°C).
Power reduction : It is possible to specify for each solenoid valve a different power reduction value.
Solenoids are energized at full power, after 1 second the pwm circuit reduce the power at the specified value.

Solid state driver with :

- Over temperature shutdown (with auto-restart)
- Short circuit protection (current limit)
- Full diagnostic capability
- Active clamp
- Open load detection in On and Off state

Number and power of the SOV depends on the supply unit and the number of SOV that must be energized at the same time.

Connect earth of SOV at the earth connection bar inside the ST2.



USER MANUAL SmarTrak (ST2)



Proportional Valve

ST2_Channel 1 : Proportional Valve A1 and A2
ST2_Channel 2 : Proportional Valve A3 and A4

Voltage output : 24V (pwm circuit allow the use of 12V solenoid).
Current output : hardware limit at 2,7A.

Tested with ATOS 12V , ATOS 18V, Wandfluh 24V, Bosch.

Selection of the type of proportional valve, minimum and maximum current is made by sw.

Power supply

Different solutions are available.

AC universal input (standard solution) :

The power supply module is fitted inside the controller enclosure.
Power supply module is a PhoenixContact QUINT-PS/1AC/24DC/20 able to supply 24V= with a current up to 20A.

Input range :
Nominal 100 V AC ... 240 V AC
AC range 85 V AC ... 264 V AC
DC range 90 V DC ... 350 V DC



DC 24V= input :

The power supply module is fitted inside the controller enclosure.
Power supply module is a PhoenixContact QUINT-PS-24DC/24DC/10
Check that the total power required (depending from the number of solenoid and from the schematic) is less than 240W

DC 24V= input without isolation :

No power supply module is fitted inside the enclosure. The power supply is provided from the customer. Care must be taken in the selection of cable size and length (possible problems : voltage drop, heating, noise).
We suggest to use a dedicated 24V= for each SmarTrak.

Options

(must be fitted in an external enclosure) :

Phoenix contact 2938963 Redundancy Module QUINT-DIODE/40
Phoenix contact 2866239 Uninterruptible Power Supply Unitfor Universal Use QUINT-DC-UPS/24DC/20
Phoenix contact 2866213 QUINT-BUFFER/24DC/20



USER MANUAL SmarTrak (ST2)



How To (advanced user configuration guide)

Configure SOV and TRIP

You must have a clear picture of what you want the SOV do.

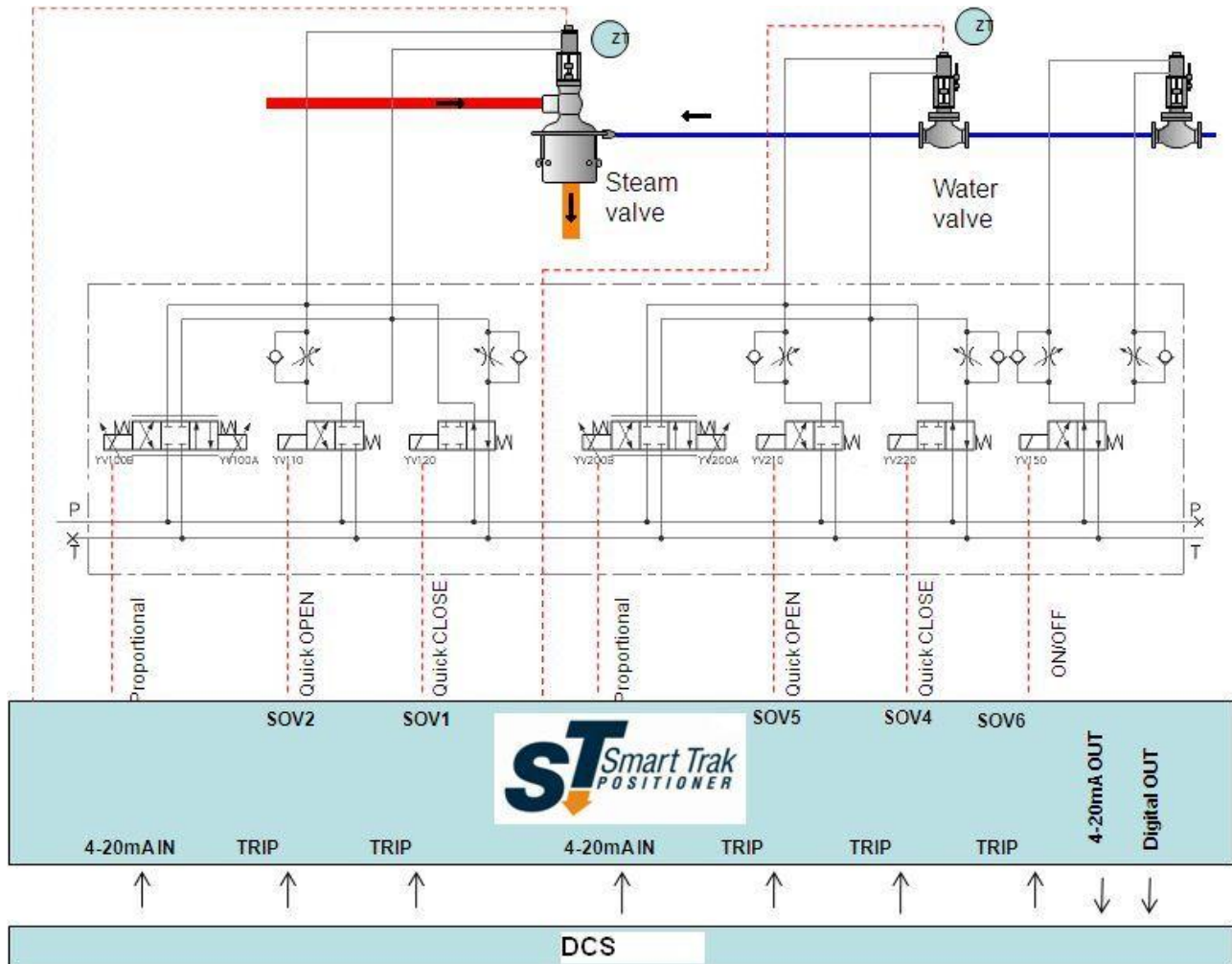

Referring to the standard schematic showed you have :

- SOV1 Related to channel 1 , function Quick Close
- SOV2 Related to channel 1 , function Quick Open
- SOV3 Not used
- SOV4 Related to channel 2 , function Quick Close
- SOV5 Related to channel 2 , function Quick Open
- SOV6 Direct driven from TRIP for ON/OFF water valve

- TRIP1 Quick Close command input for channel 1
- TRIP2 Quick Open command input for channel 1
- TRIP4 Quick Close command input for channel 2
- TRIP5 Quick open command input for channel 2
- TRIP6 ON/OFF water valve command



USER MANUAL

SmarTrak (ST2)



For each TRIP signal you must know :

- The type of the TRIP signal (24Vac, 24Vdc, Free contact)
- The activation status of the TRIP (Energized, NotEnergized)

In our example we can consider the most standard configuration :

Trip Signal type = Free Contact

Activation Status = Not Energized

Setting the the Trip signal Type :

Set the SW2 and SW6 DIP-SWITCH all in the ON position like described in the 'TRIP : Digital Input' paragraph (If you have some Trip signal powered at 24Vdc or 24Vac you must turn the specific dip-switch in the off position).

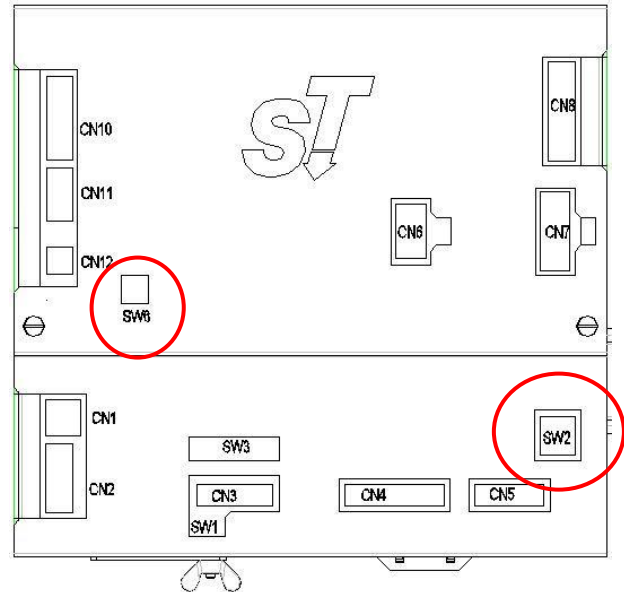

Setting the Activation Status :

For TRIP1,2,4,5 select 'NotEnergized' in the RemoteControl panel.

Select the proper SafetyShutdown mode for each trip :

TRIP1=SSD1/OFF , 'NotEnergized' =SafetyShutdown1CH1when NOTEnergized

TRIP2=SSD2/OFF , 'NotEnergized' = SafetyShutdown2CH1 when NOTEnergized

TRIP3=OFF/OFF It is not used

TRIP4=OFF/SSD4 , 'NotEnergized' = SafetyShutdown4CH2 when NOTEnergized

TRIP5=OFF/SSD5 , 'NotEnergized' = SafetyShutdown5CH2 when NOTEnergized

TRIP6=OFF/OFF , Energized Must Be configured for DirectDrive in the SOV configuration panel

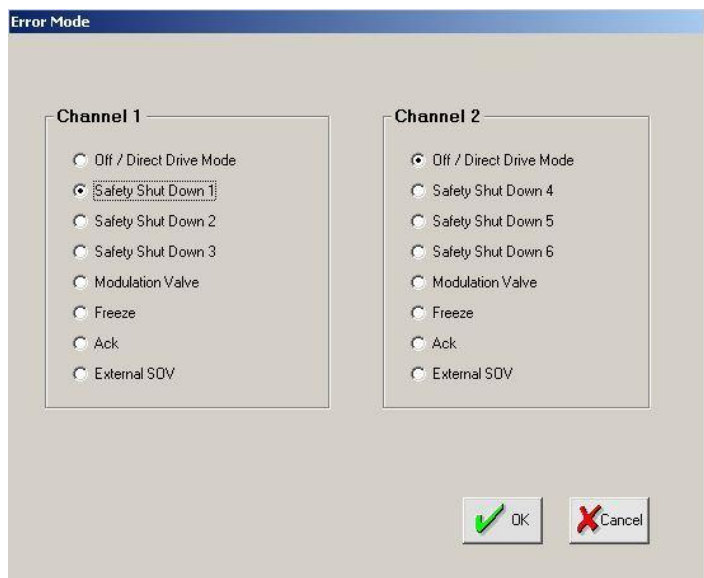
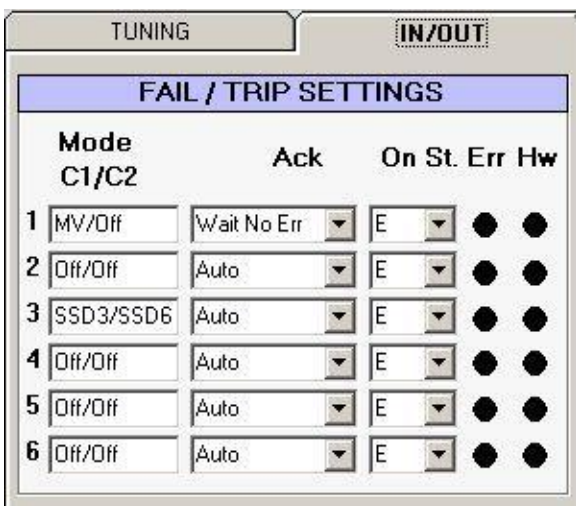



USER MANUAL

SmarTrak (ST2)



Setting the SOV :

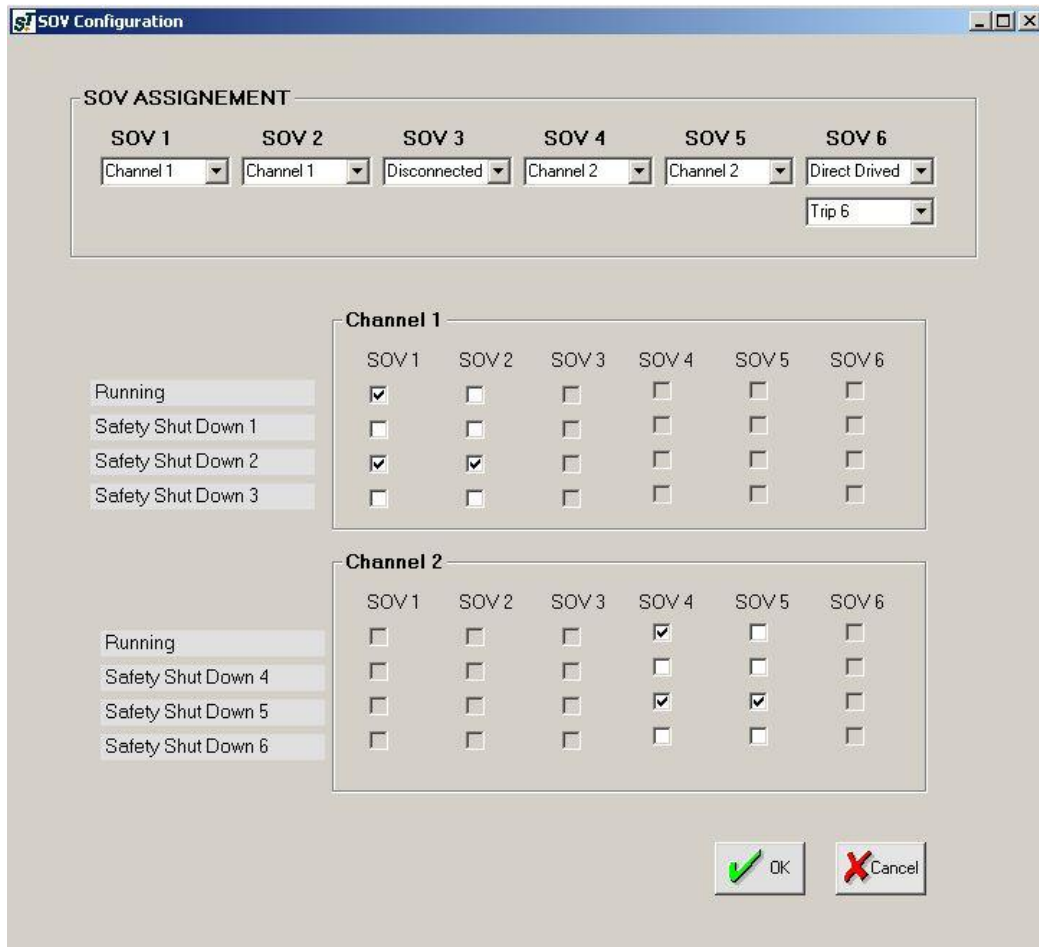

Set the SOV like showed in the picture.

Explanation :

Channel 1

When the SmarTrak channel 1 is in running (normal operation mode when the system is calibrated), SOV1 is energized and SOV2 is deenergized. The two ON/OFF valves are in the 'close' position, so the only valve that can control the actuator is the proportional one.

If TRIP1 is activated SOV1 is deenergized (and also SOV2) : the quick close on/off SOV drive the actuator in the CLOSE position.

If TRIP2 is activated SOV1 is energized ('close') and SOV2 is energized ('open') : the quick open on/off SOV drive the actuator in the OPEN position.

Channel 2

Same of channel 1 but with SOV4, SOV5, TRIP1, TRIP2

SOV6 : This SOV is directly drived from TRIP6. When TRIP6 is activated ('Energized') it turns on the SOV6 that open the ON/OFF valve.



USER MANUAL SmarTrak (ST2)



Configure Power reduction and test the SOV

To reduce the power consumption of the solenoids, power reduction can be configured. With that on the one hand the power dissipation of the power supply and the solenoids can be reduced, on the other hand the life time is going to be increased. The power reduction is by means of pulse-width-modulation.

With longer lines between the SmarTrak and the solenoids, pay attention that the control voltage on the solenoid through the voltage drop on the lines must not under 17 V.

When the solenoid is turned on, full power is applied for 1 second, after this time the power is reduced to the value specified (in %) in the specific configuration field.

Default value is 100% that means that power reduction is not applied.

If you specify a value of 75% it means that after 1 second the pwm circuit works at 75% with an equivalent voltage of $24V * 75\% = 18V$

Test the SOV :

Manual Setting allow to Turn ON and OFF the SOV for diagnostic purpose (this feature is available only when the related channel is not calibrated)

The *Feedback led* indicates if the SOV is connected and works properly (the electronic circuit is able to recognize if the SOV is not connected or if it is in short circuit)

The *Set led* indicates if the required SOV status made by the sw.

'*Use feedback control*' enable error management of the SOV.

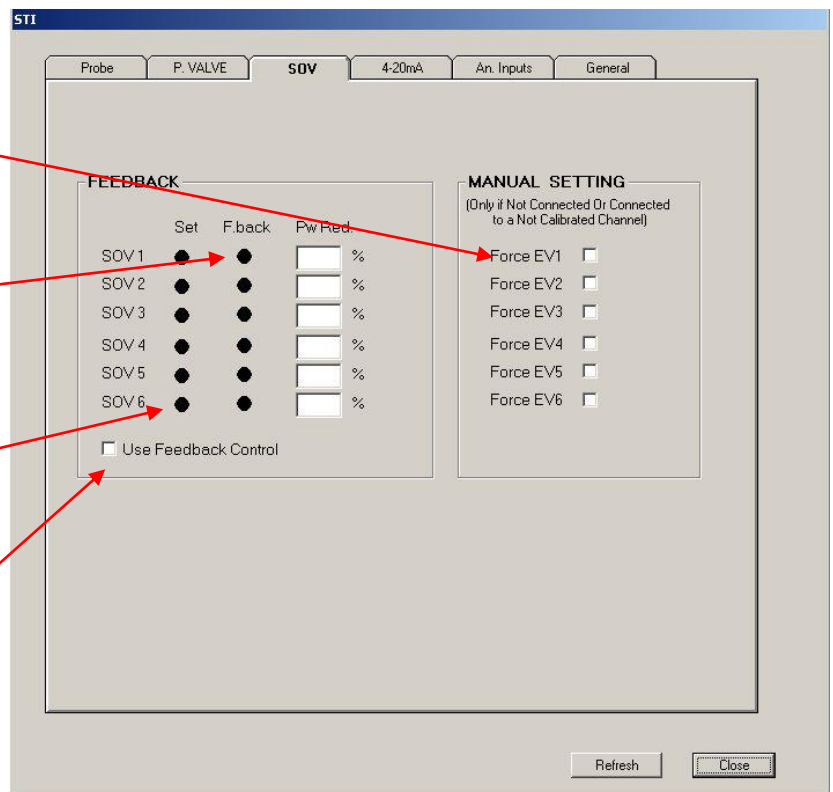



USER MANUAL

SmarTrak (ST2)



Configure the Proportional Valve

Select the type of proportional valve

You can select from different types of proportional valves.
Each proportional valve has a specific minimum and maximum current.
When you select a specific proportional valve, default values for this valve are loaded.

During the calibration the positioner use these values for reference and find proper configuration for :

- PwmMin : minimum driver power able to move slowly the actuator
- PwmMax : default value if 'Calibration Type = manual' or pwm value able to drive the theoretical max current

FB CURRENT VALUE : Show the current applied at the proportional valve.

MANUAL CONTROL : Allow to drive manually a proportional valve for diagnostic purpose (only when the channel is not calibrated).

Tips & Tricks:

If you have a very little actuator but you have a big size proportional valve you can modify manually the PWMmax parameter in order to increase the performance of the system.

Reducing the PWMmax value you can use big Kp :

- Kp is bigger : the system is quick and able to reduce the residual error (reduce the deadband).
- PWMmax is lower : the proportional valve can't be open at full flow rate (even if you have a big kp you can reduce overshoot and instability).



USER MANUAL

SmarTrak (ST2)



TROUBLE SHOOTING

Problem description	Cause	Solution
1. The controller doesn't switch on	1.1 The power is not connected 1.2 the power supply voltage is out of the admissible range (+/-10%) 1.3 the fuses are blown 1.4 some wiring is not properly done either inside the controller 1.5 there is a short circuit on some of the devices connected to the controller	1.1 Connect the power 1.2 check the power supply voltage value with a multimeter 1.3 replace the fuses 1.4 check the wiring using the electrical diagram 1.5 disconnect all the terminal boards connected to these device and check whether the controller switches on.
2. Probe error	2.1 some wiring is not properly done 2.2 the software selection in STI menu of the used probe is not correct 2.3 the probe has been calibrated with a shorter stroke process valve 2.4 the probe is damaged	2.1 check the wiring 2.2 check that the software setting corresponds to the used probe 2.3 erase the previous calibration and perform a new calibration 2.4 replace the probe
3. Proportional valve is not working properly	3.1 the proportional valves connectors are not properly plugged 3.2 the wiring is not properly done	3.1 check the connector plug 3.2 check the wiring
4. A change in the valve position set point doesn't affect the actuator's position	4.1 the oil pressure value is too low 4.2 the proportional valve is sticking 4.3 the parameters configuration is not correct 4.4 actuator and/or jammed valve 4.5 signal wires are not properly connected 4.6 circuit boards are defective 4.7 calibration and tuning have not been carried out 4.8 device is in "manual" or "out of service" mode 4.9 device is in fail safe status	4.1 check the oil pressure value 4.2 check that the proportional valve can slide smoothly 4.3 check gain and dead band values 4.3 check that the actuator can move in a continuous way and not in steps 4.5 check signal wires 4.6 replace circuit boards 4.7 perform a calibration and make the proper tuning 4.8 set the system in "in service" mode 4.9 check whether the solenoid valve making the fail safe mode is energized
5. Overshooting or positioning too slow	5.1 incorrect tuning in terms of dead band and gain 5.2 the proportional valve is sticking 5.3 too small oil tubing or dirty oil filter 5.4 leakages in oil tubing and manifold connections 5.5 process valve is sticking	5.1 change the dead band and gain values 5.2 check that the proportional valve can slide smoothly 5.3 check oil tubing size with the factory and inspect oil filter 5.4 check leakages in oil tubing and manifold connections 5.5 check process valve
6. Low signal fail limit	6. Low signal fail limit	6.1 check that the signal wires are properly connected to the terminal board 6.2 check with a multimeter the value of the signal
7. Position excess error	7. Position excess error	7. see point 4. of this table
8. Position excess warning	8. Position excess warning	8. see point 4. of this table



USER MANUAL

SmarTrak (ST2)



9. Hard limits error	9. Hard limits error	9.1 check the probe is working properly 9.2 check that the oil supply value is not too low
10. Error on solenoid valve SOVx	10. Error on solenoid valve SOVx	10.1 check that the solenoid valve's coil is not burnt 10.2 check the wiring between the solenoid valve and the controller
11. Calibration erased	11. Calibration erased	11. This is a warning message used to inform that a calibration parameters reset has been performed by the operator
12. Waiting ACK		12. in order to go back to normal operation an "ack" command must be provided
13. External SOV warning	13. this is a warning message showing that a solenoid valve not energized by the controller has taken the system into the fail safe position	



USER MANUAL

SmarTrak (ST2)



ST2Mono : single channel version

Based on the same electronic, a single channel version is available.

The electronic is partially mounted , the terminal board is different, the sw is the same and is able to recognize if the electronic is suitable for a double channel or for a single one.

Differences :

	ST2	ST2Mono
TRIP digital Inputs	6	4
SOV	6	3
Proportional valve driver	2	1
4-20mA Analog Output	2	2
Digital Output	3	3
Start/Stop Feedback Probe	2	1
4-20mA Feedback Probe	2	1
Analog inputs	6	3
4-20mA inputs (setpoint)	2	1
Hart	✓	✓
RemoteControl	✓	✓
SD Card	✓	✓

ST2Mono Power supply :

When the power supply selected is the 24Vdc the power supply adapter is the same for the ST2 and the ST2Mono (see chapter 'Power Supply' of this IOM).

When the power supply selected is 'AC Universal Input' a specific unit is used for the single channel version (Phoenix QUINT-PS/1AC/24DC/10) able to delivery up to 10A.

ST2Mono : terminal board

4-20ma Probe 1	1	4-20ma signal
	2	GND
START/STOP Probe 1	3	nSTART/STOP
	4	START/STOP
	5	nINIT
	6	INIT
	7	+24 Probe
Position demand 'A' (with HART)	8	RX4-20_1+ (HART)
	9	RX4-20_1- (HART)
4-20ma OUT 1	10	TX4-20_1+
	11	TX4-20_1-
4-20ma OUT 2	12	TX4-20_2+
	13	TX4-20_2-
	14	GND
	15	+5SENS_PRESS
Pressure Sensors	16	+24SENS_PRESS
	17	ANALOG_IN1
	18	ANALOG_IN2
	19	ANALOG_IN3



USER MANUAL

SmarTrak (ST2)



Digital Inputs (TRIP)

20	TRIP1 COM
21	TRIP1+
22	TRIP1-
23	TRIP2 COM
24	TRIP2+
25	TRIP2-
26	TRIP3 COM
27	TRIP3+
28	TRIP3-
29	TRIP4 COM
30	TRIP4+
31	TRIP4-

Digital Outputs

32	RELE' 1C
33	RELE' 1O
34	RELE' 2C
35	RELE' 2O
36	RELE' 3C
37	RELE' 3O

ON/OFF valves

38	SOV1+
39	SOV1-
40	SOV2+
41	SOV2-
42	SOV3+
43	SOV3-

Proportional Valves

44	PROP_VALVE_A+
45	PROP_VALVE_A-
46	PROP_VALVE_B+
47	PROP_VALVE_B-

Power Supply

48	
49	
50	EARTH

Information in this manual is protected by copyright. All rights are reserved. No part of this manual and relevant mentioned and/or enclosed documentation may be reproduced without written authorization by **STI S.r.l.**

STI S.r.l. is not responsible for possible damage to people, equipment or data which might arise from incorrect use of the product to which the manual is referred.

Information in this document may be modified at any time without notice.